



Nuvation Energy Multi-Stack Controller

Product Manual

Document ID: NE-PM-004 | Revision: 3.4, 2025-01-13

MSC Software Version: 21.8.0
© 2025 Nuvation Energy

Table of Contents

1. Introduction	2
1.1. About this Manual	2
2. System Overview	3
2.1. Multi-Stack System Architecture	4
2.2. Features	6
2.2.1. Main Functions	6
2.2.2. Unified View Operator Interface	6
2.2.3. Communications & Data Analytics	7
2.2.4. Maintenance and Management	7
3. Installation Instructions	8
3.1. Mechanical Installation	8
3.1.1. Dimensions and Weight	8
3.1.2. Installation Location and Position	8
3.2. Multi-Stack Controller Electrical Connections	10
3.2.1. Getting Started	10
3.2.2. Multi-Stack Controller External Interfaces	10
3.2.3. Step 1: Connect Stack Switchgear Communications	11
3.2.4. Step 2: Connect External Network or System	12
3.2.5. Step 3: Verify Grounding	16
3.2.6. UPS Configuration	16
3.3. Multi-Stack Controller First Power-Up	18
3.3.1. Connect Power	18
3.3.2. Status LEDs	20
4. Using the Multi-Stack Operator Interface	22
4.1. Access the Multi-Stack Operator Interface	22
4.1.1. External Computer Requirements	22
4.1.2. Launch Multi-Stack Operator Interface	23
4.2. The Dashboard Tab	25
4.2.1. Warnings and Faults	25
4.2.2. Pack Voltage	26
4.2.3. Pack Current	26
4.2.4. State-of-Charge	26
4.2.5. Depth-of-Discharge	27
4.2.6. Stack Voltage	27
4.2.7. Stack Current	28
4.2.8. Cell Voltage	29
4.2.9. Cell Temperature	30
4.2.10. Nuvation Energy BMS Status	31
4.3. The Stack Status Tab	34
4.3.1. Pack Connection/Status	35
4.3.2. Stack Enable and Connection	35
4.3.3. Stack Service Lockout	35

- 4.3.4. Stack COM Fault 36
- 4.4. The Data Explorer Tab 38
- 4.5. The Logs Tab 40
- 4.6. The Details Tab 42
 - 4.6.1. Safety 42
- 5. Using the Platform Interface 44
 - 5.1. Launch Platform Interface 44
 - 5.2. Functions 46
 - 5.2.1. Installing a Function 46
 - 5.2.2. Upgrading a Function 46
 - 5.3. Networks 47
 - 5.3.1. Networking 47
 - 5.3.2. Configuration 48
 - 5.4. Backups 49
 - 5.4.1. Create a System Backup 49
 - 5.4.2. Upload a Backup File 49
 - 5.4.3. Backup Restore 50
 - 5.5. Settings 51
 - 5.5.1. Upgrading the Multi-Stack Controller 51
 - 5.5.2. Factory Reset the System 52
 - 5.5.3. Rebooting the System 52
 - 5.5.4. Powering off the System 52
 - 5.5.5. Setting the Date, Time, and Timezone 52
 - 5.5.6. Configuration Import and Export 53
 - 5.6. Logs 54
 - 5.6.1. Downloading Logs 54
- 6. Communication Protocols 55
 - 6.1. Modbus Protocol Support 55
 - 6.1.1. Modbus TCP 55
 - 6.1.2. Implemented SunSpec Energy Storage Models 55
 - 6.1.3. SunSpec Energy Storage Models Structure and Nomenclature 56
 - 6.1.4. Operational Cases for SunSpec Modbus Interface 58
 - 6.1.5. Accessing SunSpec Energy Storage Models 61
- 7. External Interfaces 63
 - 7.1. Ethernet 63
 - 7.2. SFP+ Interfaces 63
 - 7.3. Power Button 63
 - 7.4. DC Power Connector 63
- 8. Troubleshooting 64
 - 8.1. Faults 64
 - 8.1.1. Controller Heartbeat 64
 - 8.1.2. Ready Stacks 64
 - 8.1.3. Configuration Fault 64
 - 8.1.4. BMS Firmware Mismatch 64

8.1.5. Current Imbalance	65
8.2. Lost/Forgotten IP Address	66
8.2.1. Wireshark (Windows/Linux)	66
8.2.2. Netdiscover (Linux only)	66
Appendix A: Operating Limits	67
Electrical Characteristics	67
Environmental Conditions	67
Standards and Certifications	68
Appendix B: Ordering Information	69
Appendix C: Battery Topology Terminology	69
Appendix D: Best Practices	70
Excess Cable Management	70
Security	70
Physical Security	71
Network Security	71
Appendix E: Appendix D: List of Supported Equipment.	74
Supported UPS Devices	74
Supported Display Devices	74

The content in this document must be followed in order to ensure safe operation of Nuvation Energy BMS.



Do **NOT** energize the system until all connections to the Multi-Stack Controller have been made.



Properly insulate or remove any unused wires. Unused wires can couple excessive system noise into Nuvation Energy BMS which can disrupt communication and lead to undesirable behaviors.



Please be aware of high voltages present in your system and follow all necessary safety precautions.



The provided module enclosures are not fire enclosures.

1. Introduction

Thank you for choosing Nuvation Energy.

The Nuvation Energy BMS is an enterprise-grade Battery Management System with features that extend battery life, ensuring pack-level safety, data-analytics, and remote management.

The Nuvation Energy Multi-Stack Controller aggregates information and provides a unified interface to a large multi-stack battery system.

1.1. About this Manual

This *Nuvation Energy Multi-Stack Controller: Product Manual* is a comprehensive manual, providing:

- Details about all the features offered by your Nuvation Energy Multi-Stack Controller
- Mounting and wiring instructions to install this product safely
- Guidance on operating the device to control your multi-stack Energy Storage System



This document applies to Multi-Stack Controller 21.8.0 software release (Firmware versions Faraday, Descartes and Curie, Multi-Stack Operator Interface version 1.11.0, nplatform version 2.3.5). Content may be inaccurate or incomplete for other versions.



We thrive on your feedback and what we build is driven by your input. Please submit support tickets to support@nuvationenergy.com.

2. System Overview

The Nuvation Energy Multi-Stack Controller aggregates all battery stacks within a multi-stack Energy Storage System. It enables operation of the overall system as a single unified battery, while still providing stack-level control.

This product functions as a central battery control hub for other control systems. These may include PCSs and/or energy controllers. Through this hub, such control systems can obtain and respond to battery data and send control commands to the battery system.

The Multi-Stack Controller can be used to manage up to 16 battery stacks in parallel, and will bring up stacks in the sequence best suited to the immediate use-case requirement, i.e. power, energy, or capacity.

The Multi-Stack Controller provides two crucial battery-level software interfaces for large, multi-stack battery applications:

1. Modbus TCP:

- Unified view of the entire battery conforming to open energy standards
- Conforms to SunSpec Energy Storage Models: 802, 803, 804, 805 Models
- Used directly by inverters and other grid infrastructure implementing the SunSpec Energy Storage Models (Draft 4)

2. Web-based configuration and diagnostics:

- Hosts web-based tools that can be accessed from common web browsers
- Used to configure settings and view diagnostic information for the entire battery system

A few key system-level features that are also provided are:

- System-wide statistics for voltages, temperatures, and currents
- Current limiting algorithms for multi-stack battery systems
- State-of-Charge algorithms for multi-stack battery systems
- NTP client for BMS time synchronization



Figure 1. Nuvation Energy Multi-Stack Controller

2.1. Multi-Stack System Architecture

A typical multi-stack system, equipped with Nuvation Energy's suite of BMS products, is illustrated in [Figure 2, "Multi-Stack Controller system diagram"](#). There is a hierarchy of battery management involved, each product fulfilling its role at a different level:

- At the cell level, a Cell Interface module measures voltage/temperature and balances cells as required.
- At the stack level, a Stack Switchgear unit measures current and connects/disconnects its stack as required, as well as incorporates other stack safety features. Battery safety is handled at the stack level.
- At the system level, a Nuvation Energy Multi-Stack Controller unit manages all stacks as described above.

For a given stack, the daisy-chained Cell Interface modules report data to and receive direction from the Stack Switchgear. In turn, the Stack Switchgear reports data to and receives direction from the Multi-Stack Controller. Here, a unified view and central control of the multi-stack system is provided to the user as well as any external devices.



Cell Interface modules and Stack Switchgear units are sold separately. Datasheets, along with product manuals, are available online at <https://nuvationenergy.com/technical-resources>.

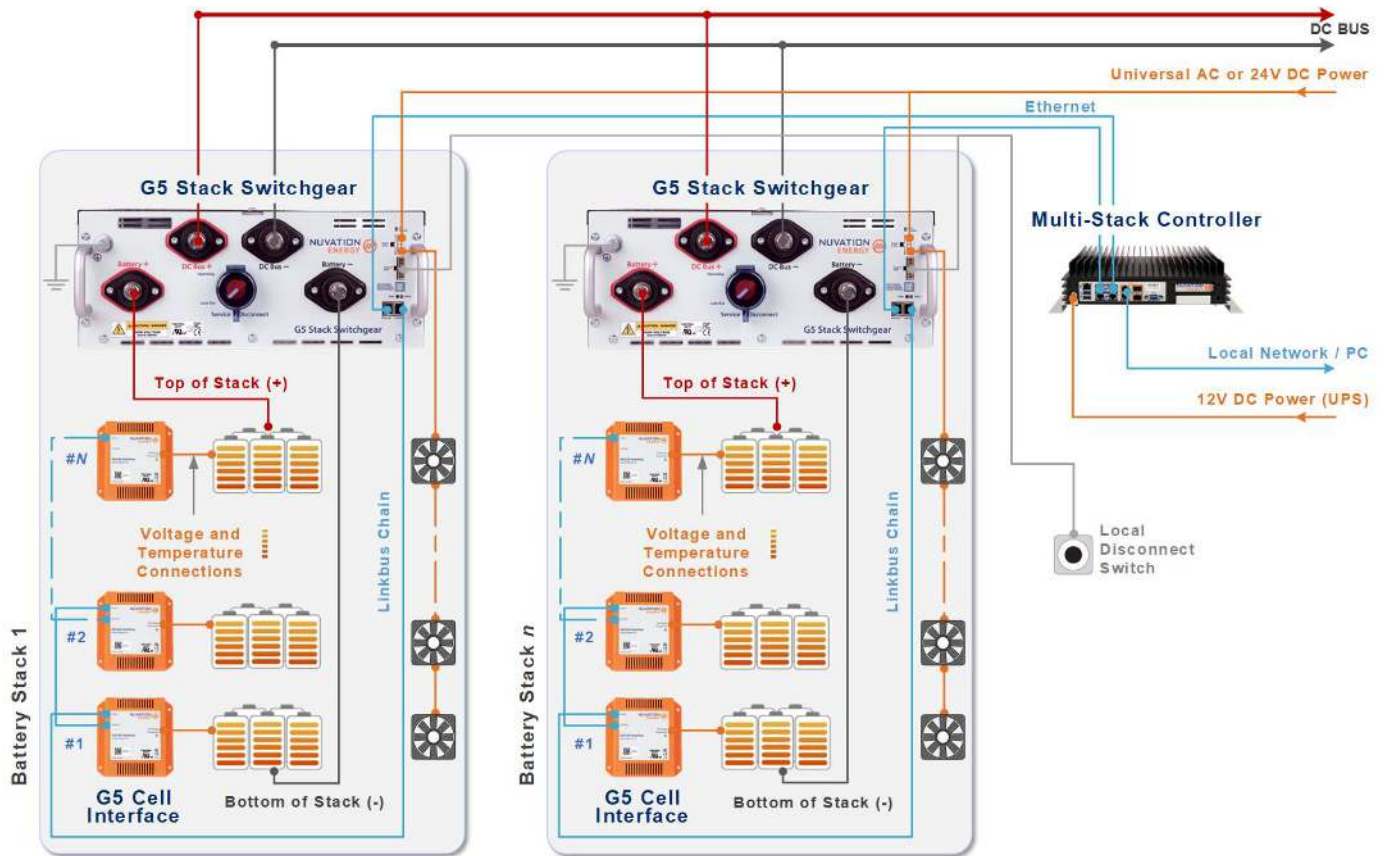

Figure 2. Multi-Stack Controller system diagram

The Multi-Stack Controller is offered in variants based on the number of battery stacks to which it will be connected. Variants are available in 4-stack increments, up to a maximum of 16 stacks.

The Multi-Stack Controller is available in a compact hardware form-factor or in a rack-mounted hardware form-factor. This document describes the compact form-factor. The document for the rack-mount form-factor is available upon request.

Designed in compliance with SunSpec (<https://sunspec.org/>), the Nuvation Energy Multi-Stack Controller was created specifically for integration with a wide range of batteries and inverters, and is designed to work with the following Nuvation Energy BMS products:

- G5 Stack Switchgear
- G4 Stack Switchgear
- Stack Controller
- Low-Voltage BMS

Orderable part numbers are listed in [Appendix B, Ordering Information](#).

2.2. Features

2.2.1. Main Functions

Manages multiple stacks

Manage up to 16 stacks.

Provides Unified View of Entire Battery

Access diagnostics and performance data of entire multi-stack battery from a single unified user interface.

Provides Remote Access

Remote access for data analytics or for viewing and adjusting battery operation remotely via web browser on a PC, tablet computer, or even on a smartphone.

Automates System-Wide Fault Response

Manually or automatically identify and act upon faults anywhere in the battery pack.

Communications

Communicate securely over Ethernet. Provides unified interface for site controllers to multiple stacks.

Automatic Pack Connection

Allows the BMS to manage the connected state of all battery stacks within the pack. When requested, the Multi-Stack Controller will connect all stacks if they do not violate the pack connection voltage limit. Stacks are automatically connected when the limit is no longer violated (i.e. when the stack voltage becomes close enough to the pack voltage that is safe to connect).

Maximize Pack Uptime and Connection

Provides a flexible configuration to manage battery stack faults at a pack level. A Nuvation Energy support technician can configure a battery pack to tolerate a specified number of stacks that fault and disconnect from the DC bus. The Multi-Stack Controller allows the pack to remain operational and manage the reduced power capacity of the battery.

2.2.2. Unified View Operator Interface

A Browser user interface, which supports Chrome and Firefox, provides a view of:

Statistics View

Monitor pack-level statistics for voltage, temperature, and current across all cells.

Real-Time View

Monitor measurement and control information in real-time.

Aggregate State-of-Charge

View State-of-Charge calculated values for the entire battery.

Flow-Through I/O

Control all points in the BMS from a single interface.

Communications Status

Reports networking communication status and communication issues from stacks within the pack.

Faults and Warnings

Monitor all system-wide faults and warnings or—for a finer level of control—drill down into detailed battery pack diagnostics.

2.2.3. Communications & Data Analytics

Isolated BMS Network Traffic

Separate Ethernet ports isolate BMS network traffic from external network traffic, helping ensure your Energy Storage System is hardened and reliable.

Inverter Support

Modbus TCP supports SunSpec Energy Storage Models for connection to PCSs as well as other external systems through multiple concurrent client connections.

2.2.4. Maintenance and Management

Multi-Stack Current Limiting

Determine operating current limits for entire pack, which can be read by the external system to control the inverter, protecting the battery pack from over-charging or discharging.

Pack-Level Fault Response

A highly configurable architecture allows a Nuvation Energy support technician to specify system faults and desired responses. The Multi-Stack Controller flags faults anywhere in the battery pack and automatically takes preventive action to keep the battery functional and healthy.

Servicing

Bring stacks online/offline for service, maintenance, modifications, etc. Selectively connect multiple stacks to the DC power bus.

Network Environment Flexibility

A multi-socket Ethernet interface allows concurrent operation of both local and remote operator panels, monitoring data and interfacing with inverters over Modbus TCP. SFP+ interfaces allow long-distance fibre connectivity without external hardware.

Provides Remote Support

The Multi-Stack Controller provides the option of a secure VPN connection to a Nuvation Energy server which grants Nuvation Energy support engineers remote access to check on the health of the battery pack and aid the local site commissioning team.

3. Installation Instructions

3.1. Mechanical Installation

3.1.1. Dimensions and Weight

The overall dimensions of the Multi-Stack Controller are 340 mm × 218.5 mm × 89.8 mm.

The Multi-Stack Controller module weighs approximately 4.5 kg (9.9 lb).

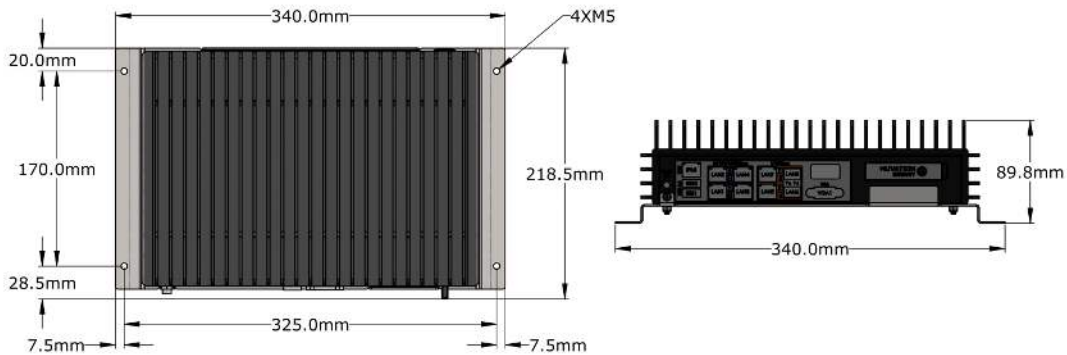

Figure 3. Mechanical Drawing of Multi-Stack Controller

3.1.2. Installation Location and Position

The Multi-Stack Controller is rated to operate in the temperature range of 5 °C to 40 °C. It is designed for indoor use.

For best thermal performance, the Multi-Stack Controller should be mounted to a flat vertical surface such that the face with the Ethernet / Power connectors is pointing up.

The Multi-Stack Controller can be mounted using four M5 screws.

3.1.2.1. Mounting Clearances

Extra space should be provided around the module to allow for cable connections, easy installation and maintenance, and to provide adequate fan-less cooling. The spatial clearance is illustrated below.

3.2. Multi-Stack Controller Electrical Connections



Before making any connections, ensure that power is not applied to the Multi-Stack Controller.

3.2.1. Getting Started

Before connecting power to the Multi-Stack Controller you need to:

1. [Connect Stack Switchgear communications](#)
2. [Connect external network or system](#)
3. [Verify grounding](#)
4. [UPS configuration](#)

3.2.2. Multi-Stack Controller External Interfaces

Below are images of the external interfaces available on the front and back of the Multi-Stack Controller.



Figure 5. Multi-Stack Controller external interfaces (front)



Figure 6. Multi-Stack Controller external interfaces (back)

The following table outlines the port connections of the Multi-Stack Controller.

Table 1. Network Port Connection Map

Port Name	Function	Port Label	Port Speed
External	Manage network traffic external to the Multi-Stack Controller. Operator Interface is accessed from this port.	7 & 8	1/10 Gbps

Port Name	Function	Port Label	Port Speed
Internal	Manage traffic from Nuvation Energy BMS stacks.	1-4	10/100/1000 Mbps
		5 & 6	1/10 Gbps

These port numbers refer to the numbering found on the front panel, as shown in the image below.

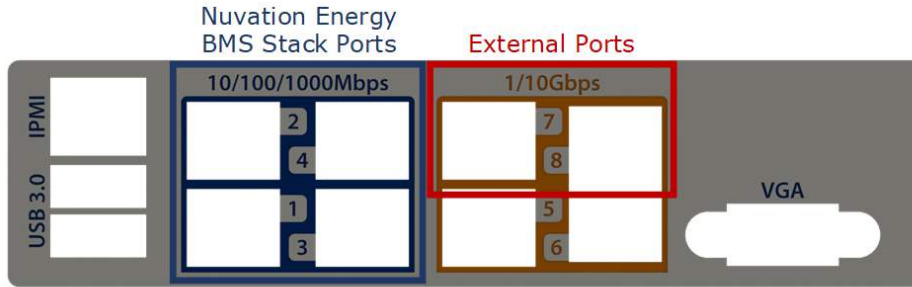

Figure 7. Multi-Stack Controller port types

The Multi-Stack Controller supports the following types of ports:

- 4x internal Ethernet ports at 10/100/1000 Mbps (ports 1-4)
- 1x internal Ethernet port at 1/10 Gbps (port 5)
- 1x internal SFP+ port at 1/10 Gbps (port 6)
- 1x external Ethernet port at 1/10 Gbps (port 7)
- 1x external SFP+ port at 1/10 Gbps (port 8)

3.2.3. Step 1: Connect Stack Switchgear Communications

To connect the Stack Switchgear units to the Multi-Stack Controller, connect the Stack Switchgear units to Ethernet RJ45 ports labelled 1 to 4 using Cat5e-rated or higher Ethernet cables of suitable lengths.



The Stack Switchgear only supports ports at 10/100 Mbps Ethernet. To connect a Stack Switchgear to port 5 or 6, an Ethernet switch supporting 1 Gbps and 10/100 Mbps is required.

Depending on the Multi-Stack Controller variant purchased, you may also use an external unmanaged network switch to connect more than 4 Stack Switchgear products to the Multi-Stack Controller.



The *external* and *internal* networks of the Multi-Stack Controller should remain separated and independent for the best operation of the battery pack. Excessive network traffic on the *internal* network can interfere with the Multi-Stack Controller management of the stacks.

3.2.4. Step 2: Connect External Network or System

The Ethernet RJ45 port labelled 7 or the SFP+ port labelled 8 may be used to connect the Multi-Stack Controller to an external system, such as:

- Energy control systems, such as PCSs and energy controllers
- A laptop, to configure operating parameters and observe status
- A local area network (LAN) connection, for wired internet access
- An Ethernet switch, to access any number of the above devices

The External Ethernet interface is a standard Cat5e-rated RJ45 jack, supporting only 1 and 10 Gigabit speeds. Any Cat5e-rated or higher Ethernet cable of suitable length may be used to connect to this RJ45 jack.



Connecting both ports 7 & 8 at the same time will create a loop and will cause interference with the operation of the external network.

No connection should be made to the IPMI port unless directed by Nuvation Energy.

Refer to the network port connection map [Table 1, "Network Port Connection Map"](#).

Depending on the number of stacks, the local area network and the existence of an external controller, the Multi-Stack Controller networking setup might change.

A typical networking configuration for a Multi-Stack Controller with 4 stacks is demonstrated below.



In the following diagrams, green components are customer-supplied, and blue components are available from Nuvation Energy.



See [Best Practices - Network Security](#) for a description of the recommended secure networking configuration.

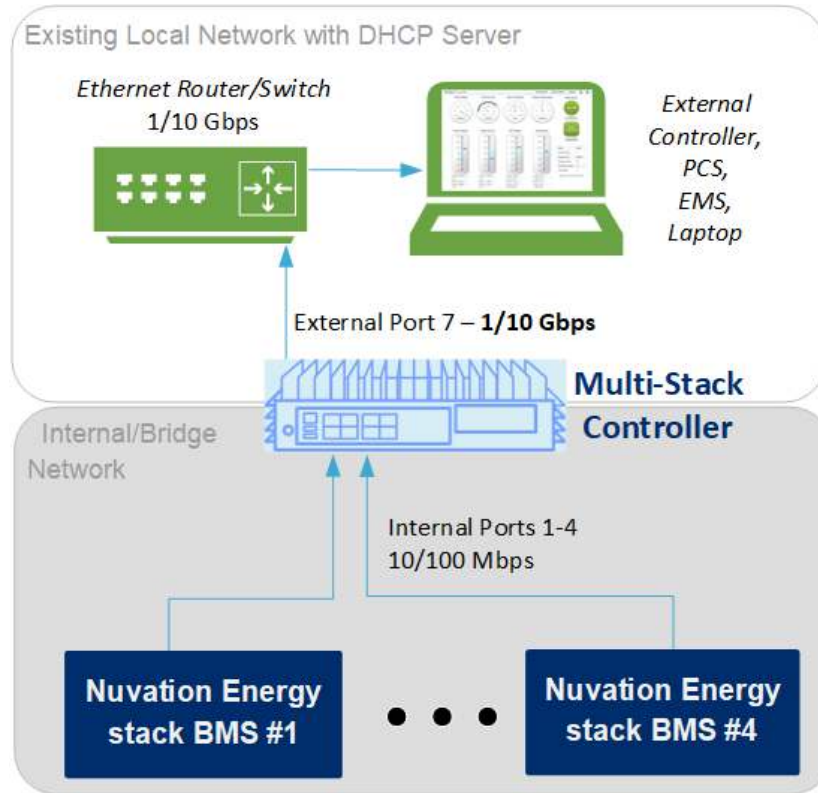

Figure 8. Typical networking configuration for a Multi-Stack Controller 4 stack variant

For a Multi-Stack Controller 8+ stack variant, an ethernet switch is needed for connecting the stacks with the Multi-Stack Controller. Refer to the below diagram for configuration details.

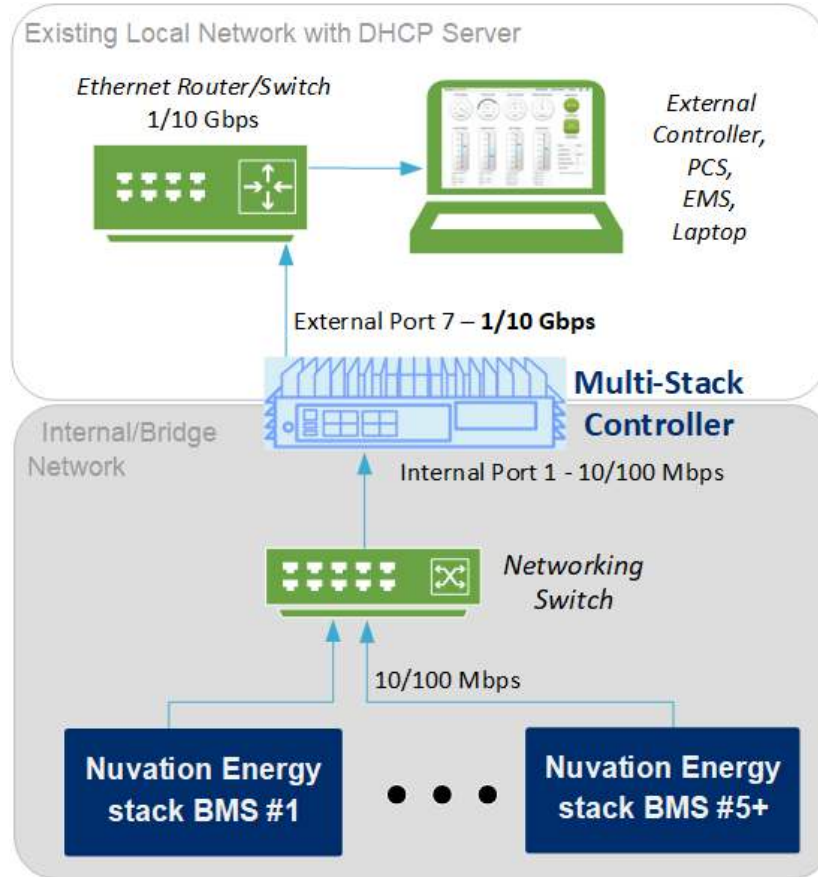

Figure 9. Typical networking configuration for a Multi-Stack Controller 8 stack variant

In the case where the external controller does not support 1 Gbps and only supports 10/100 Mbps, a compatible ethernet switch must be added. Refer to the below diagram for configuration details.

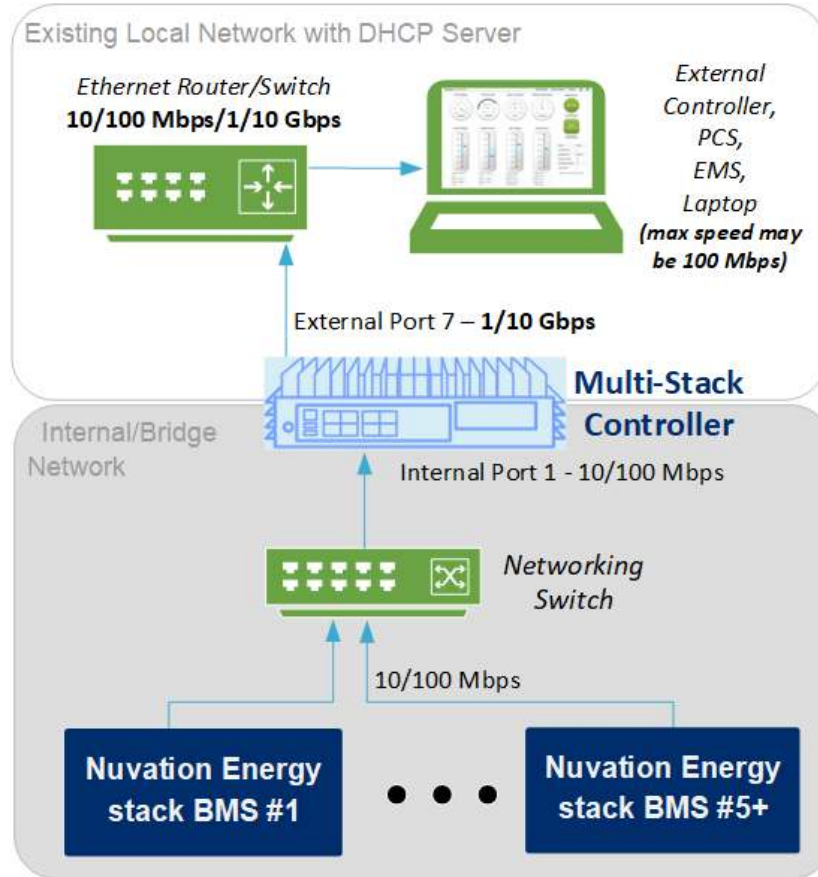

Figure 10. Typical networking configuration for a Multi-Stack Controller 8 stack variant with an ethernet switch

In the case where a WiFi extender is needed, refer to the below diagram for configuration details.

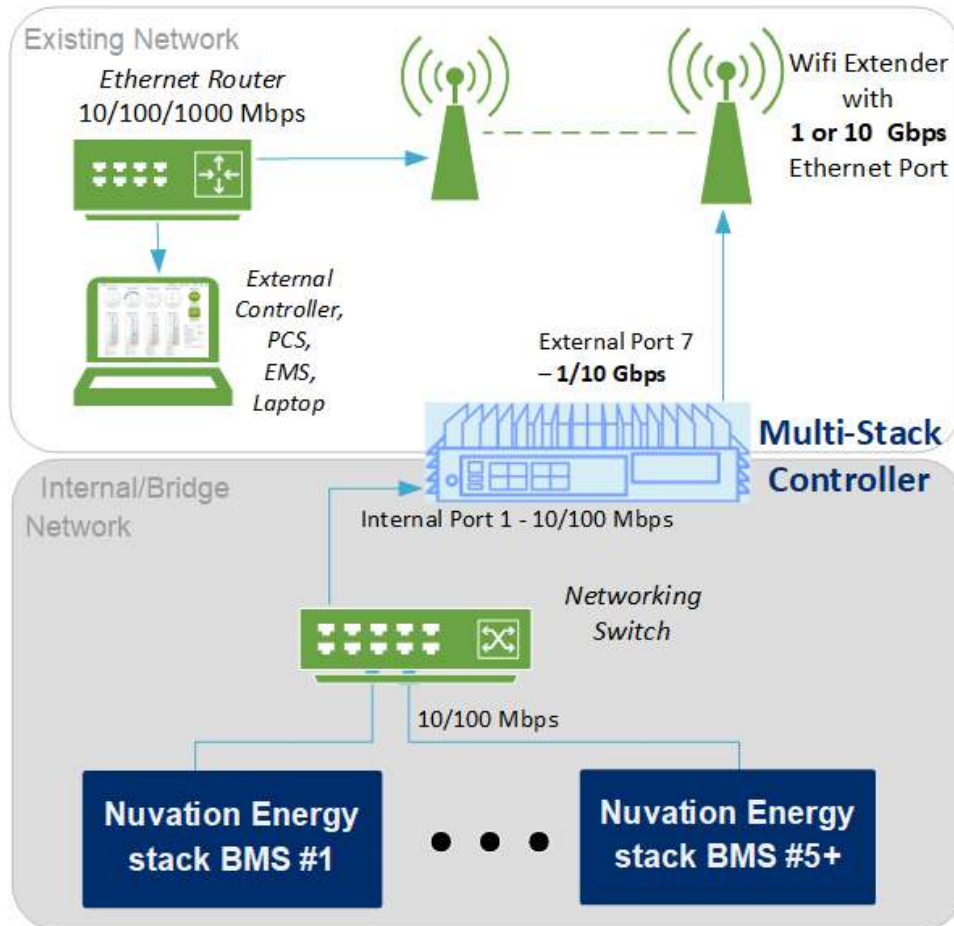

Figure 11. Typical networking configuration for a Multi-Stack Controller 8 stack variant where a WiFi extender is placed from stack location to local network

3.2.5. Step 3: Verify Grounding

The Multi-Stack Controller must be mounted to an Earth-bonded metal structure to maintain a reliable ground. This references all components internal to the Multi-Stack Controller to earth ground, as the negative input of the DC power connector is also connected to the chassis. Earth ground is also passed along to shielded connectors (e.g. Ethernet and USB).



The external supply has its negative input connected to earth ground through the Multi-Stack Controller module's chassis.

These instructions assume that attention is paid to proper grounding instructions and best practices for all Stack Switchgear units and Cell Interface modules. Please refer to the stack-level *Product Manual* for this information.

It is also assumed that similar measures are taken for other components of the Battery Energy Storage System such as the batteries and the PCS.

3.2.6. UPS Configuration

An uninterruptible power supply (UPS) is a device that allows connected equipment to continue running when incoming power is temporarily interrupted. A UPS also allows for the safe, orderly shutdown of the connected equipment by providing protection from instantaneous power disruptions.

The Multi-Stack Controller provides support for an external UPS that can be plugged into the USB 3.0 or Ethernet ports. Refer to [Figure 5, "Multi-Stack Controller external interfaces \(front\)"](#) for the location of USB ports. The list of compatible UPS devices can be found in [Supported UPS Devices](#). Only UPS devices which can connect via USB or Ethernet are supported.

Support for UPS includes the following features:

- Auto shutdown : When the UPS is running on battery, and it reaches the critical low battery level, the UPS will initiate a shutdown procedure. This procedure will trigger the connected Multi-Stack Controller to gracefully shut down before UPS shuts off power
- Timeout : This feature allows the Multi-Stack Controller to operate on battery mode for a configurable period of time and then automatically power off the connected UPS alongside a graceful shutdown. This is useful when some UPS capacity should be reserved for a black start of the system. In a black start scenario, the Multi-Stack Controller UPS should be connected to the energy storage system to ensure the UPS can maintain continuous operation after black start of the energy storage system.

Please reach out to support@nuvationenergy.com for support on configuring UPS device with Multi-Stack Controller. The UPS features cannot be configured directly and will work with default settings as specified during the ordering process.

3.3. Multi-Stack Controller First Power-Up

3.3.1. Connect Power

Identify an appropriate AC power source

The AC power source must not be derived from the energy system itself without an ability to maintain (or turn on) the supply when the energy system is powered off (i.e. black start).

An external UPS can be used between the energy system-derived AC source and the supply providing power to the Multi-Stack Controller when an external AC power source is not available. When using a UPS, please ensure the Multi-Stack Controller’s power side is connected to UPS power instead of the external AC power outlet.

[Table 2, “12 V Power Supply Specifications”](#) shows the specifications of the 12V power supply that can be ordered with the Multi-Stack Controller. If using a different 12V power source, the supply must meet the power requirements listed in [Appendix A, Operating Limits](#).

Table 2. 12 V Power Supply Specifications

Symbol	Parameter	Min	Typical	Max	Units
V_{input_AC}	Input Voltage AC	90		264	V AC
f_{input_AC}	Input Frequency	47	50/60	63	Hz
I_{input_AC}	Input Current AC			2	A AC
V_{output_DC}	Output Voltage DC		12		V DC
I_{output_DC}	Output Current DC			12.5	A DC
P_{output}	Output Power			150	W

Powering up the system

Verify that all the mechanical and electrical installation steps are completed and the Multi-Stack Controller is connected to the Stack Switchgear units, network, and power.

When ready to power on the Multi-Stack Controller, connect the DC power connector and then enable AC power. The Multi-Stack Controller turns on automatically when power is applied; however, following a shutdown, the power button can be used to manually turn on the Multi-Stack Controller as an alternative method to simply power-cycling the device.

The Multi-Stack Controller will emit a 4-tone startup chime when low-level software has started. This will be followed by a 3-tone chime once all software has been initialized. The Nuvation Energy BMS Operator Interface will be accessible shortly after this chime.

To shutdown the system, momentarily press the power button to initiate a graceful shutdown of the Multi-Stack Controller. A graceful shutdown is always recommended before unplugging the power supply.



The Multi-Stack Controller initiates a factory restore after 10 sequential unsuccessful boot sequences. To avoid this situation, ensure that the unit is fully powered up before power cycling.

In the event the unit has initialized a factory restore, please contact support@nuvationenergy.com to bring the unit back to a functional state.

3.3.2. Status LEDs

When the Multi-Stack Controller is powered up, its status LEDs provide indication of the functional status of the module and its interfaces. The Operator Interface provides additional information.

The Power LED indicates the status of the Multi-Stack Controller.



Figure 12. Multi-Stack Controller Power LED

Table 3. Power LED Description

LED	Colour	Status
Power LED	Solid Blue	Multi-Stack Controller State: Operational
	Solid Teal	Multi-Stack Controller State: Reading/Writing to the Internal Storage Media
	Solid Red	Multi-Stack Controller State: Overheating or Critical Hardware Fault.
	Flashing Red	Multi-Stack Controller State: Hardware Fault

The Port LEDs indicate the status and speed of each interface.



Figure 13. Multi-Stack Controller Port LEDs

Table 4. Port LEDs Description

LED	Colour	Status
LAN1 - LAN4 Activity (A1 - A4)	Flashing Orange	LAN# State: Active

LED	Colour	Status
LAN1 - LAN4 Link (L1 - L4)	Solid Green	LAN# Speed: 10/100 Mbps
	Solid Orange	LAN# Speed: 1000 Mbps
LAN5 & LAN7 Activity (A5 & A7)	Flashing Orange	LAN# State: Active
LAN5 & LAN7 Link (L5 & L7)	Solid Orange	LAN# Speed: 1 Gbps
	Solid Green	LAN# Speed: 10 Gbps
LAN6 & LAN8 Activity (A6 & A8)	Flashing Green	LAN# State: Active
LAN6 & LAN8 Link (L6 & A8)	Solid Orange	LAN# Speed: 1 Gbps
	Solid Green	LAN# Speed: 10 Gbps
IPMI Activity (A0)	Flashing Orange	IPMI State: Active
IPMI Link (L0)	Solid Green	IPMI Speed: 10/100 Mbps
	Solid Orange	IPMI Speed: 1000 Mbps

4. Using the Multi-Stack Operator Interface

4.1. Access the Multi-Stack Operator Interface

The Multi-Stack Operator Interface can be accessed from any computer/tablet with the latest Firefox or Chrome web browser.

4.1.1. External Computer Requirements

An external computer, like a laptop or a PC, is required to perform the setup steps. Ensure the following requirements have been met when selecting a computer.

4.1.1.1. Network Connection

It is recommended to connect the computer to the same network as the *External Ethernet* on the Multi-Stack Controller. The default settings for the *External Ethernet* are DHCP, and requires the network to have an active DHCP server. Most corporate networks and routers will have a DHCP server.

If a DHCP capable network is not available, (i.e. if the computer must be connected directly to the Multi-Stack Controller via an ethernet cable) it is recommended to initially connect to one of the *Internal Ethernet* ports. The Multi-Stack Controller has a static IP default on the *Internal Ethernet* network with the following settings:

- Static IP: 192.168.1.10
- Net mask: 255.255.255.0

Ensure the computer networking is configured with a static IP of 192.168.1.x where x cannot be 0, 10 or 255 to enable communication with the Multi-Stack Controller. It is recommended once the initial connection has been made, to configure the *External Ethernet* port to the desired settings and connect the computer to that network rather than using the *Internal Ethernet*. See [Section 5.3, "Networks"](#) for details on configuring network settings.



An internet connection is not required for the product to function. However it does use the Network Timing Protocol (NTP) to maintain its clock accuracy.

4.1.1.2. Computer OS Compatibility

Ensure the Operating System of the laptop/computer supports multi-cast DNS (mDNS).

Table 5. Operating Systems that support mDNS

OS	Version	Additional Software Required
Windows	10	N/A
Windows	8 and lower	Apple Bonjour
MacOS	10.2 and higher	N/A
Linux	N/A	Avahi



mDNS is also operational when a Static IP is configured.

Manual IP Discovery



In the event that the computer does not support mDNS, the MAC address for the external network port is labeled on the exterior of the Multi-Stack Controller.

Look for this MAC address in the DHCP server to determine which IP address was assigned to the Multi-Stack Controller and navigate to 'http://<ip-address>' from a compatible web browser rather than the mDNS URL http://ncontroller-serial_number.local.

4.1.2. Launch Multi-Stack Operator Interface

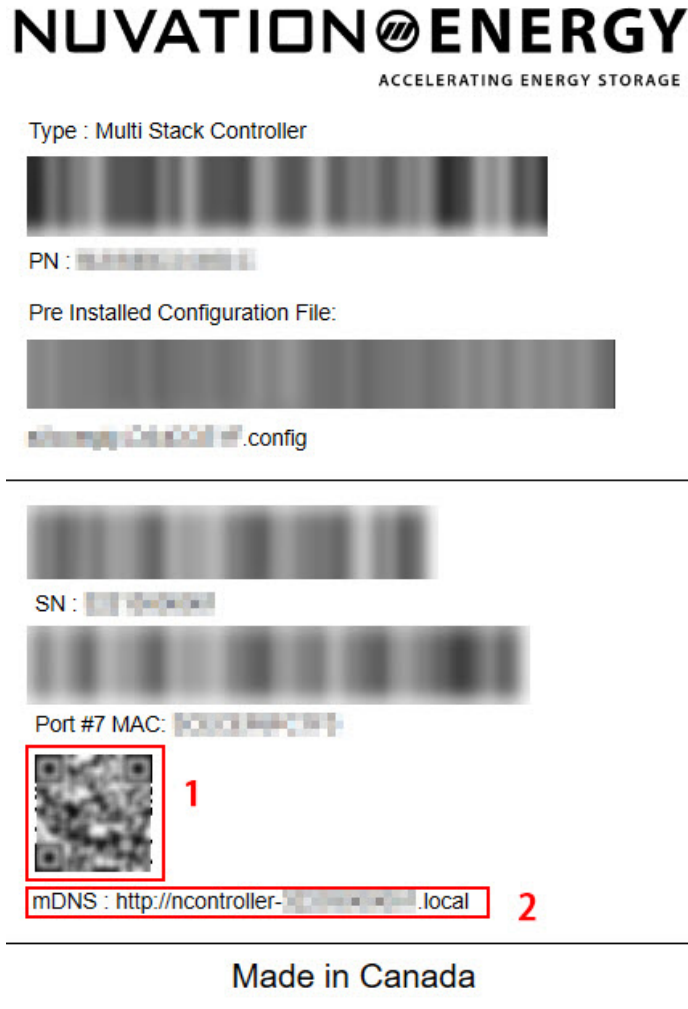

Figure 14. Multi-Stack Controller label

The above figure is the label on the exterior of the product. To access the Multi-Stack Controller Operator Interface, navigate to the URL http://ncontroller-serial_number.local from a compatible computer (see [Section 4.1.1, "External Computer Requirements"](#)), replace <serial number> with the

Multi-Stack Controller serial number in section 2 of the label. The same URL can also be accessed by scanning the QR code in section 1 of the label.



The Multi-Stack Operator Interface currently supports the most recent versions of Mozilla Firefox and Google Chrome. Other browsers such as Internet Explorer are not supported.

4.2. The Dashboard Tab

The default tab of the Operator Interface is the Dashboard. The Dashboard contains a high-level overview on the state of the battery pack. This is the only page required for daily monitoring of the battery pack.

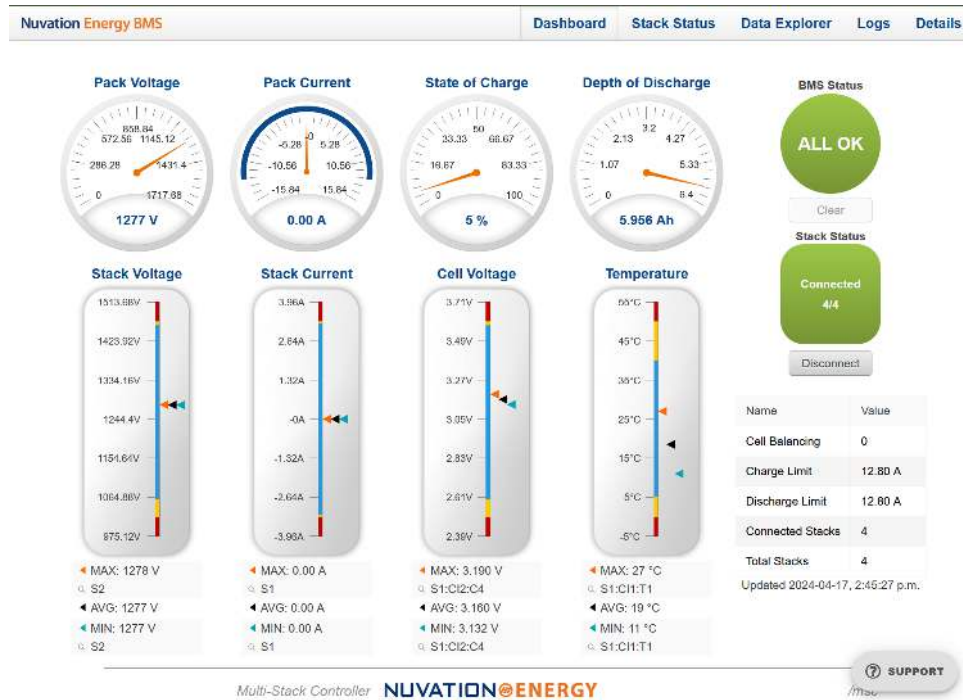

Figure 15. Nuvation Energy BMS Operator Interface Dashboard screenshot

4.2.1. Warnings and Faults

Before going into the details of the gauges and information presented in the dashboard, it is important to understand what a fault and a warning Nuvation Energy BMS status means.



An ALL OK indicates that there are no faults or warning. This is the normal state for Nuvation Energy BMS.



A Warning indicates the state of the battery system has been detected outside of its normal operational range. The cause of the warning should be identified and a corrective action should be performed. For instance, if the warning is a thermistor temperature measurement has become too hot, the battery system should be cooled to bring the measurement back into the normal operational range.



A Fault indicates the state of the battery system has been detected outside of its safe operational range. The cause of the fault must be identified and a corrective action must be performed. For instance, if the fault is a cell voltage measurement has become too low, the cell maintenance manual must be reviewed to identify what remedial actions are required.

A Fault is more severe than a Warning and the source of the fault must be discovered and resolved before attempting to clear and continue operating the battery system.

4.2.2. Pack Voltage

The pack voltage radial gauge shows the average stack voltage of the stacks connected to the common DC bus.

If no stacks are connected, a value of 0 V is displayed.

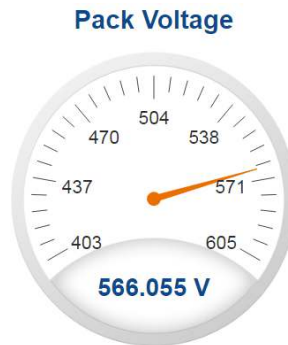

4.2.3. Pack Current

The pack current radial gauge shows the battery pack current which is the addition of each stack current that are connected to the common DC bus. The maximum charge current limit and the maximum discharge current limit is also shown. The acceptable current range is visualized on the gauge by the blue arc. An absence of the blue arc indicates the battery pack cannot be charged or discharged in its present condition.

A negative current value indicates the battery pack is charging. A positive current value indicates the battery pack is discharging.

If no stacks are connected, a value of 0 A is displayed.



4.2.4. State-of-Charge

The State-of-Charge radial gauge shows the battery stack's State-of-Charge, which is an average State-of-Charge of the stacks connected to the common DC bus. The battery stack is empty when the State-of-Charge value is 0% and full when the State-of-Charge value is 100%.

If no stacks are connected, a value of 0% is displayed.

State of Charge



4.2.5. Depth-of-Discharge

The Depth-of-Discharge radial gauge shows how much energy has been taken out of the battery stack. It is the sum of all stacks connected to the common DC bus. In an ideal Energy Storage System, defined as a system with no power losses, the amount of energy shown in this gauge needs to be added back into the battery pack to fill it back up to 100% State-of-Charge.

If no stacks are connected, a value of 0 Ah is displayed.

Depth of Discharge

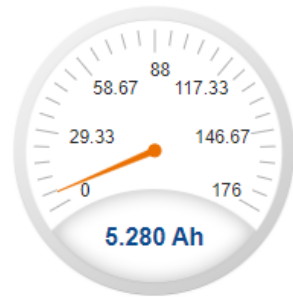

4.2.6. Stack Voltage

The stack voltage bar gauge shows the maximum, minimum, and average stack voltage measurements for all installed stacks within the battery pack.

The high stack voltage and low stack voltage warning and fault threshold is visualized on the gauge with yellow and red segments. The blue segment depicts the acceptable stack voltage range.

The maximum and minimum stack location in the pack and their voltage value are shown below the gauge, along with the average stack voltage value.

Stack Voltage

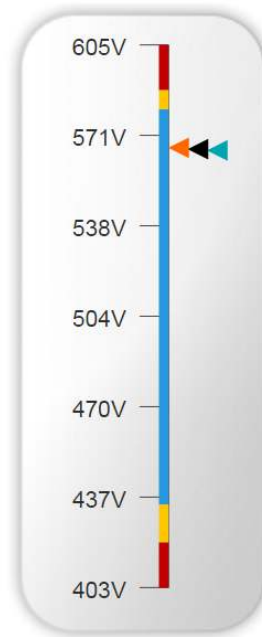

◀ MAX: 566.58 V
🔍 S2
◀ AVG: 566.055 V
◀ MIN: 565.6 V
🔍 S1

4.2.7. Stack Current

The stack current bar gauge shows the maximum, minimum, and average stack current measurements for all installed stacks within the battery pack.

The high stack discharge current and high stack charge current warning and fault thresholds are visualized on the gauge with yellow and red segments. The blue segment depicts the acceptable stack current range.

The maximum and minimum stack location in the pack and their current value are shown below the gauge, along with the average stack current value.

Stack Current

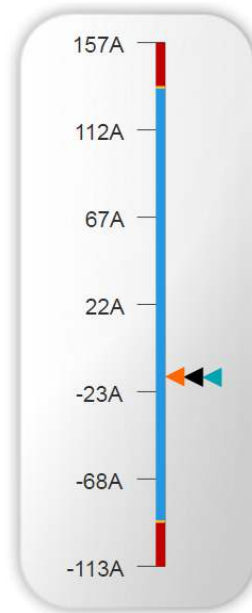

◀	MAX: -15.034 A
🔍	S3
◀	AVG: -15.266 A
◀	MIN: -15.442 A
🔍	S2

4.2.8. Cell Voltage

The cell voltage bar gauge shows the maximum, minimum, and average cell voltage measurements within the pack. Only data from installed stacks is aggregated.

The high cell voltage and low cell voltage warning and fault threshold is visualized on the gauge with yellow and red segments. The blue segment depicts the acceptable cell voltage range.

If a triangle enters the yellow segment, a warning has occurred. If a triangle enters the red segment, a fault has occurred.

The maximum and minimum cell location in the pack and their voltage values are shown below the gauge, along with the average cell voltage value.

Cell Voltage

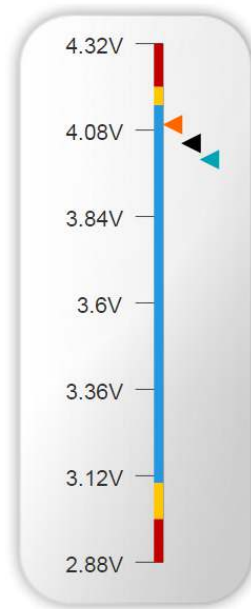

◀ MAX: 4.095 V

🔍 S3:C13:C5

◀ AVG: 4.043 V

◀ MIN: 3.998 V

🔍 S1:C14:C5

4.2.9. Cell Temperature

The temperature bar gauge shows the maximum, minimum, and average cell temperature measurements within the pack. Only data from installed stacks is aggregated.

The high cell temperature and low cell temperature warning and fault threshold is visualized on the gauge with yellow and red segments. The blue segment depicts the acceptable cell temperature range.

If a triangle enters the yellow segment, a warning has occurred. If a triangle enters the red segment, a fault has occurred.

The maximum and minimum cell location in the pack and their temperature values are shown below the gauge, along with the average cell temperature value.

Temperature

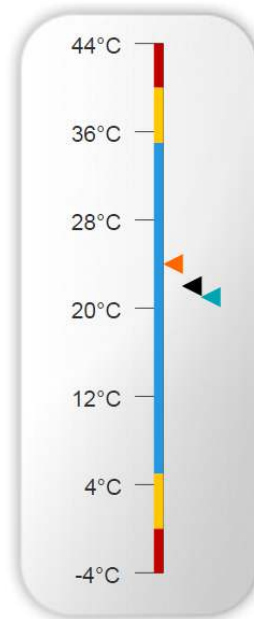

◀	MAX: 24 °C
🔍	S1:CI1:T2
◀	AVG: 22 °C
◀	MIN: 21 °C
🔍	S1:CI1:T3

4.2.10. Nuvation Energy BMS Status

Nuvation Energy BMS status information contains information on the overall safety status of the battery stacks, the battery stack connection state, number of cells balancing, maximum charge current limit, maximum discharge current, number of stacks connected, number of stacks installed in the battery pack, and the time and date of the last update of the Dashboard.

4.2.10.1. Operation Status

Nuvation Energy BMS operation state is shown in the big status circular indicator.



Figure 16. Three possible Nuvation Energy BMS operation states

The normal state is All OK and the color of the indicator will be green. The warning state is Warning and the color of the indicator will be orange. The fault state is Fault and the color of the indicator will be red.

Clicking on the indicator will jump to the [Section 4.3, "The Stack Status Tab"](#) tab where the overall fault status as well as the fault status of each stack is displayed.

Clicking on the Clear button below the state will cancel any warnings and faults that are not self-clearing.

4.2.10.2. Connection State

The battery stack connection state is shown in the oval indicator.



Figure 17. Three possible connection states

Stack Disconnected in a red oval indicates the SSG contactors are open, and the battery stack is unavailable to be charged or discharged.

Stack Pre-charging in an orange oval indicates the battery stack has connected its pre-charge circuit and is attempting to equalize the battery stack voltage to the system DC bus voltage.

Stack Connected in a green oval indicates the battery stack is available to be charged or discharged.

Clicking the Connect button initiates the stack connection sequence of events. Nuvation Energy BMS must be in the All OK state for the Connect button to be available.

Clicking the Disconnect button will disconnect the battery stack from the system DC bus.

4.2.10.3. Information Table

The information table shows the number of cells that are having excess energy bled off to maintain a balanced battery stack.

Name	Value
Cells Balancing	70
Charge Limit	-129.064 A
Discharge Limit	528 A
Connected Stacks	4
Total Stacks	4

The Charge Limit shows the maximum charge current limit value. The Discharge Limit shows the

maximum discharge current limit value.

The Charge Limit and Discharge Limit values are visualized on the Stack Current radial gauge as the limits of the blue arc.

4.2.10.4. Last Update

The Updated time and date shows the last time the Operator Interface had successfully communicated with Nuvation Energy BMS and updated all items in the Dashboard with values from Nuvation Energy BMS. The time and date are based on the local computer/tablet; it does not come from Nuvation Energy BMS.

If the communication with a Nuvation Energy BMS is lost, a notification banner appears at the top of the display screen. The information shown on the Dashboard represents the last data received and is no longer recent.

4.3. The Stack Status Tab

The Stack Status tab contains a detailed view for each installed stack in the Nuvation Energy BMS. The status of each stack is graphically represented on this page as shown below.

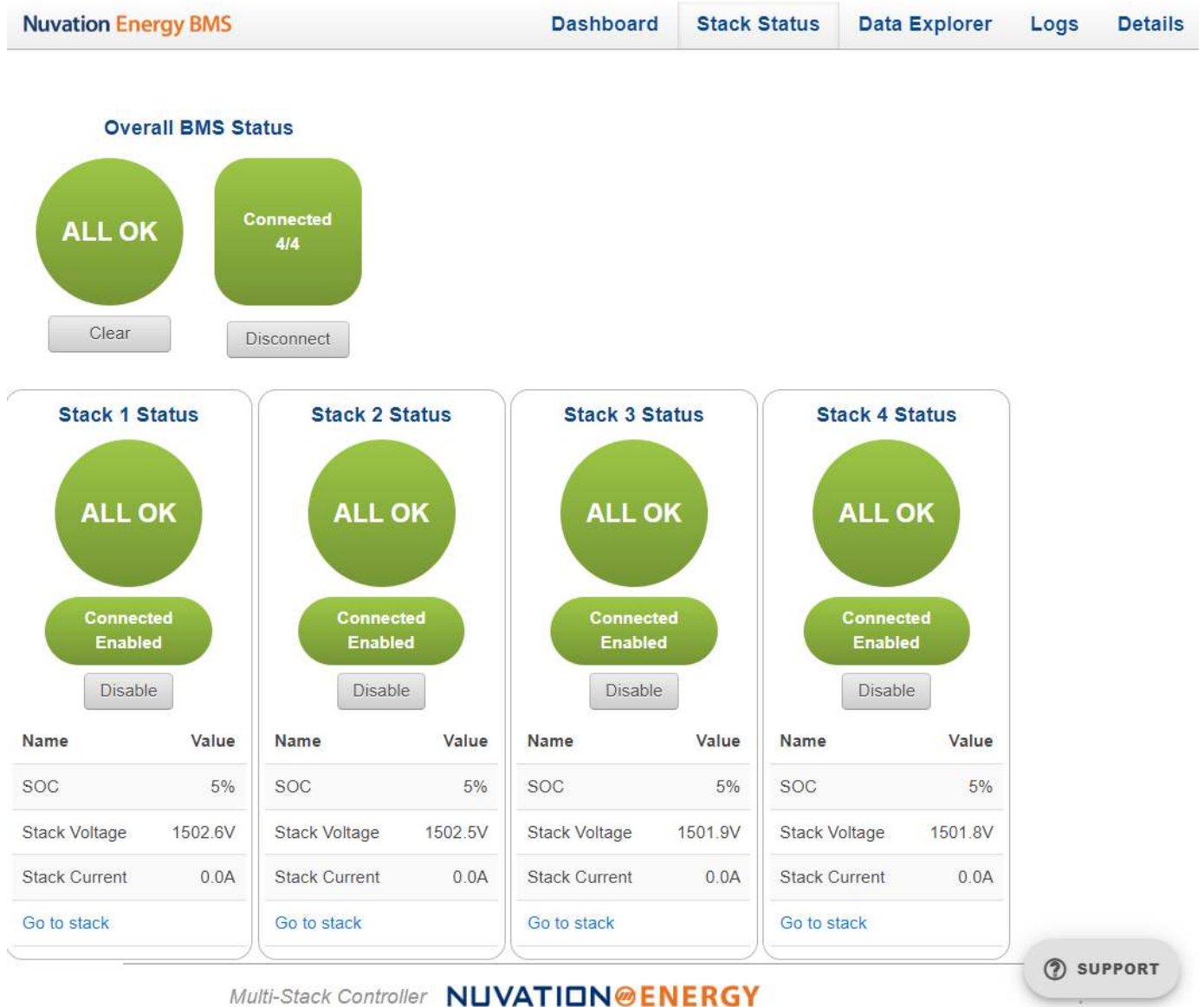

Figure 18. Multi-Stack Operator Interface Stack Status Tab Screenshot

The following information is available on each stack status:

- Overall stack status (OK/Warning/Fault/COM Fault/Service Lockout)
- Whether the stack is Enabled or Disabled
- Whether the stack is connected or disconnected to the DC bus.
- Stack measurements for SoC, voltage, and current

- Link to navigate to the stack operator interface



Figure 19. Multi-Stack Operator Interface Support Button



The SUPPORT button can be used to direct the operator to the Nuvation Energy website to contact Support.

4.3.1. Pack Connection/Status

The overall controller operation and connection status is displayed in the upper left corner of the screen. The behavior of this graphic is the same as described in the dashboard [Section 4.2.10, "Nuvation Energy BMS Status"](#). The BMS statuses of the pack or any stack is clickable to navigate to the [Safety Accordion](#) for details of all warnings and faults for the pack or a specific stack. A connect button is available when automatic pack connection has been enabled. When manual connection of a pack is configured, this connect button is removed.

4.3.2. Stack Enable and Connection

The *connected* and *enable* state of each stack is displayed in the red/green oval. A grey button labelled *Enable* or *Disable* is located below this status. The button will toggle the enable state of a stack. When a stack is changed from *enabled* to *disabled* state, the stack is immediately disconnected from the DC bus. When a non-faulted stack is toggled from *disabled* to *enabled*, there will be one of two possible outcomes:

1. If pack auto connection is enabled, the stack is considered a candidate for connecting to the pack.
2. If pack manual connection is configured, a connect button will appear on the stack status.

Please contact support@nuvationenergy.com for further details.

4.3.3. Stack Service Lockout

If a stack was to enter its *Service Lockout* state (refer to *Operator Interface Manual: Single-Stack* for details), the stack status will be updated as shown below.

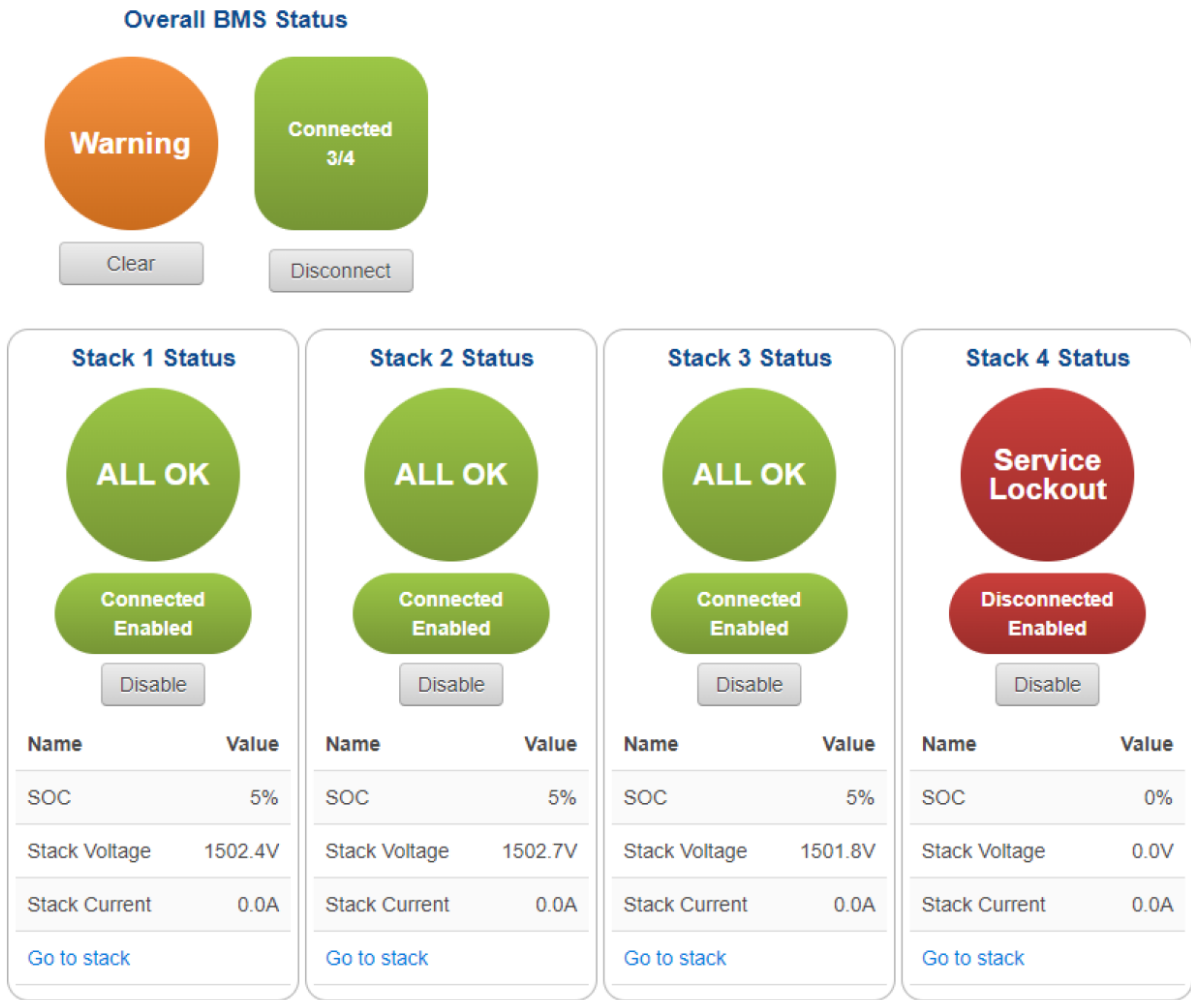

Figure 20. Stack in Service Lockout

4.3.4. Stack COM Fault

If there is a communication failure with a stack (i.e. the Multi-Stack Controller loses communication with the stack), the stack status will be updated as shown below.

Overall BMS Status



Warning

Clear



**Connected
3/3**

Disconnect

Stack 1 Status



ALL OK



**Connected
Enabled**

Disable

Name	Value
SOC	5%
Stack Voltage	1502.6V
Stack Current	0.0A

[Go to stack](#)

Stack 2 Status



ALL OK



**Connected
Enabled**

Disable

Name	Value
SOC	5%
Stack Voltage	1501.9V
Stack Current	0.0A

[Go to stack](#)

Stack 3 Status



ALL OK



**Connected
Enabled**

Disable

Name	Value
SOC	5%
Stack Voltage	1502.7V
Stack Current	0.0A

[Go to stack](#)

Stack 4 Status



COM Fault



**Disconnected
Disabled**

Enable

Name	Value
SOC	0%
Stack Voltage	0.0V
Stack Current	0.0A

[Go to stack](#)

 **SUPPORT**

Figure 21. Stack with COM Fault

4.4. The Data Explorer Tab

The data explorer tab allows read-only access of the Multi-Stack Controller information including pack and stack data and configuration.

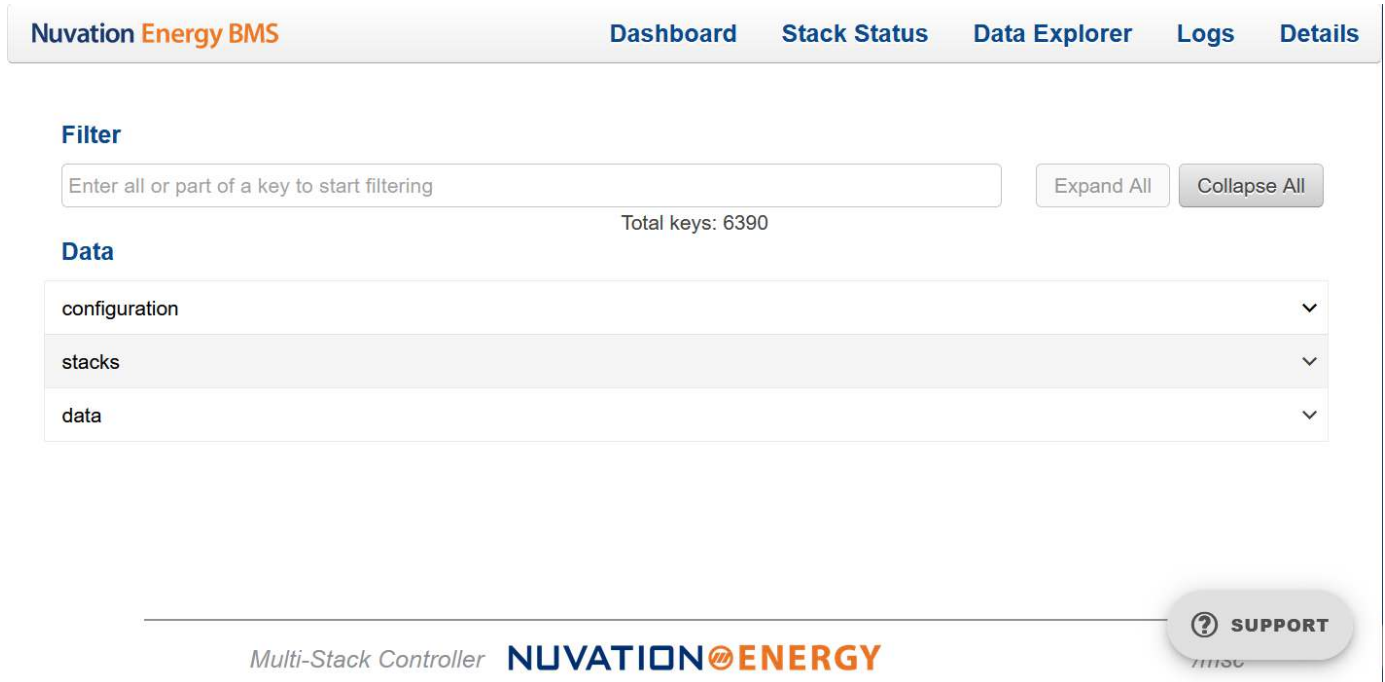

Figure 22. Data explorer

An alphanumerical search box can be used to filter through the data. The number of filtered keys appears at the bottom of the search box. The accordion can be expanded by clicking on the Expand All button to show the filtered keys along with their values. Clicking on the Collapse All button will collapse all accordions.



The Expand All button is disabled when the search yields too many keys. Filtering must be done before expansion.



Please contact support@nuvationenergy.com for details on the explorer keys.

Filter

Expand All

Collapse All

Filtered keys: 2

Data

data	^
pack	^
enabled_stacks_trigger_count	^
faults	0
warnings	0

 SUPPORT

Multi-Stack Controller **NUVATION ENERGY**

Figure 23. Data explorer filter

4.5. The Logs Tab

The logs tab can be used to download a csv file of the data measured by the Multi-Stack Controller within a specific time range.

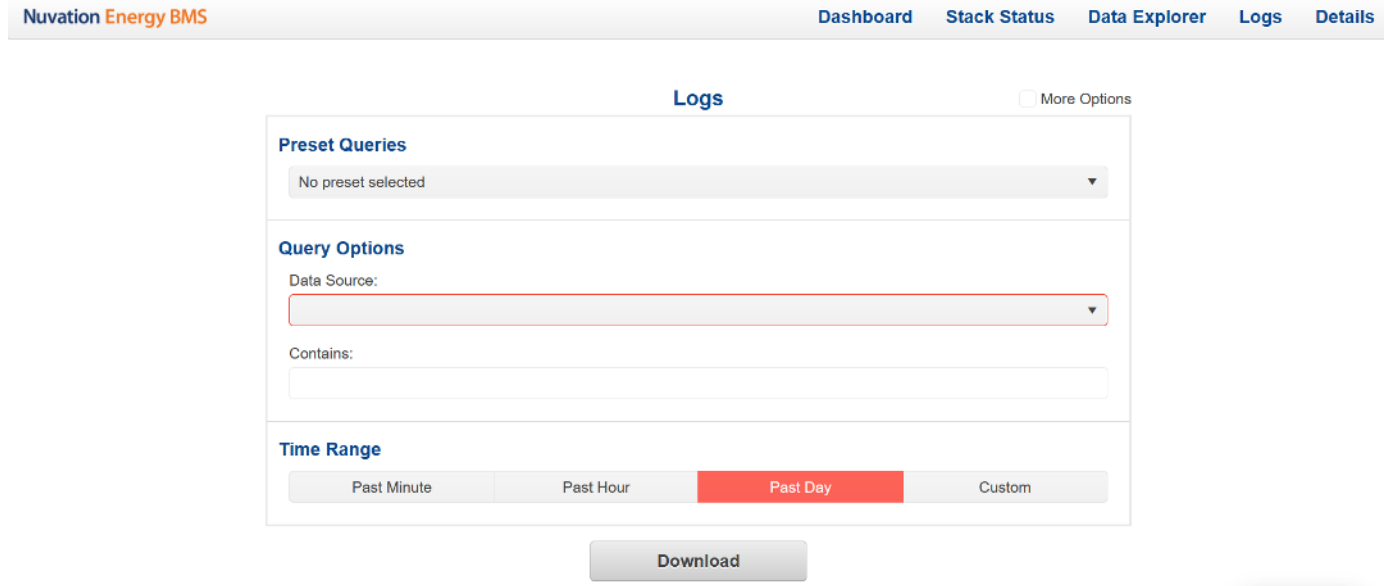

Figure 24. Logs tab

The following query options are available:

- All Measurements
- Aggregate 1 Minute Measurements
- All Text

Additionally, upon pressing "More Options" in the top right of this (OI), a filter option will be presented as seen in the following:

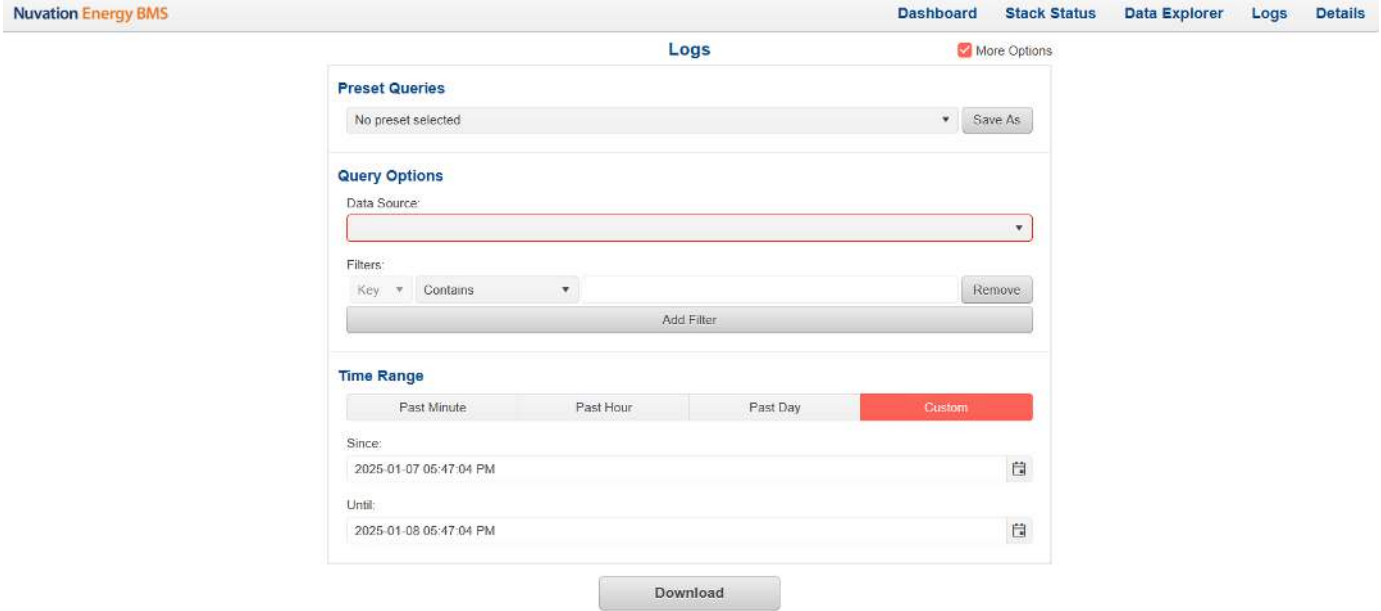

Figure 25. Logs filter tab

The filtering tool allows users to filter through the dataset using entered keys and then retrieve the filtered dataset. The available operations using this filtering function are: equals, contains, begins with, ends with, does not equal, does not contain, does not begin with, does not end with.

To download the data, choose from the time range options such as: past minute, past hour, past day and custom. In order to set a custom time range press on the timestamps and manually changing them to the desired dates, alternatively, pressing the calendar button for a visual representation. Clicking the Download button will download the csv file with the data for the selected dates. The format of the csv files will depend on the query, refer to [Table 6, "Log file format"](#).

Table 6. Log file format

Query	csv columns (time in milliseconds unix format)	Description	Retention period
All Measurements	time, key, value	Instantaneous data	7 days
Aggregate 1 Minute Measurements	time, key, average, max, min, count	1 minute data aggregates	Minimum 1 year, larger systems have shorter retention periods
All Text	time, key, value	Text data	Minimum 1 year, larger systems have shorter retention periods



For more information on the key column please contact support@nuvationenergy.com.



Downloaded files can be very large. It is recommended to download smaller time periods.

4.6. The Details Tab

The Details tab contains a much more detailed view into the status of Nuvation Energy BMS. The data values shown in this tab can be easily copied into a spreadsheet as a means of capturing the current state of Nuvation Energy BMS for manual data recording purposes.

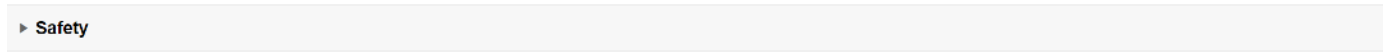
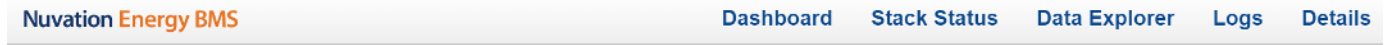

Figure 26. Nuvation Energy BMS Operator Interface Details tab screenshot



Figure 27. Operator Interface Support Button



The SUPPORT button can be used to direct the operator to the Nuvation Energy website to contact Support.

4.6.1. Safety

The Safety accordion contains a summary list of the number of Nuvation Energy BMS faults and warnings active in the battery pack well as the overall status of the battery pack. For details about the triggers, see section [Section 8.1, "Faults"](#). An active fault is shown as Tripped. An active warning or user trigger is shown as Triggered. An fault or warning that has not completed its Self Check is shown as Checking. In normal operation, all warnings and faults should be clear and the battery stack can be charged and discharged.

Some faults and warnings at the pack level are due to stack level faults and warnings. To see a summary of the faults and warnings for all the stacks, navigate to the [Stack Status Tab](#).

Nuvation Energy BMS Dashboard Stack Status Data Explorer Logs Details

Safety Updated 2024-09-27, 11:47:09 a.m.

Name	State	Trigger
Ready Stack Count Fault	Clear	fault_stacks_ready
Configuration Check Fault	Clear	fault_config_fault
Stack Configuration Check Fault	Clear	fault_stack_config_fault
Stack Logger Persistence Write Fault	Clear	fault_logger_persistence_fault
Stack Count Warning	Clear	warning_stacks_warning
Ready Stack Count Warning	Clear	warning_stacks_ready
Invalid Configurable Registers Warning	Clear	warning_invalid_configurable_registers

Figure 28. Safety accordion in Details Tab

Clicking on the Clear Faults and Warnings button at the bottom of this accordion will clear any faults that are not self-clearing. It will not clear any warnings that are not self-clearing; the Clear button on the Dashboard must be used to clear warnings that are not self-clearing.

Clicking on the Generate Report button at the bottom of this accordion will generate a safety report JSON file with a list of the Nuvation Energy BMS faults and warnings and their current state as well as the current firmware versions.

5. Using the Platform Interface

5.1. Launch Platform Interface

The Platform Interface accessible by navigating to [http://ncontroller-<serial number>.local/platform](http://ncontroller-
<serial number>.local/platform) and enables configuration and management of the Nuvation Energy Multi-Stack Controller.

This URL can be accessed via a [compatible computer](#).

Replace <serial number> with the Multi-Stack Controller serial number - this can be found on a label on the exterior of the product. Below is an example of a product label, with the relevant serial number listed beside the field "SN".

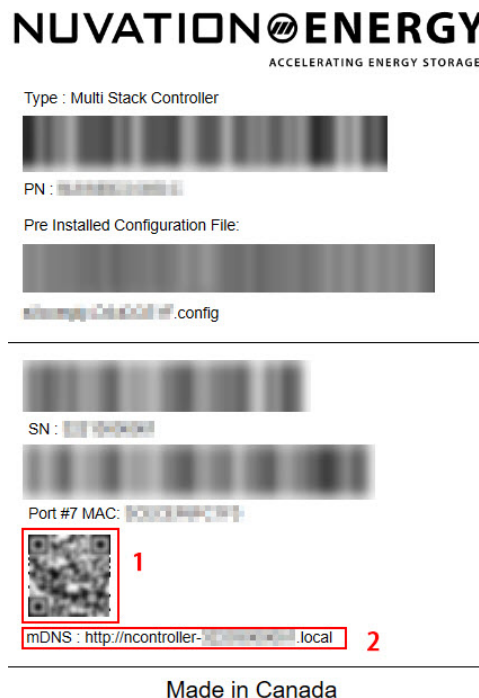

Figure 29. Sample product label



The above product label is an example, and the actual label will be different.



The Platform Interface currently supports the most recent versions of Mozilla Firefox and Google Chrome. Other browsers such as Internet Explorer are not supported.

Five main pages can be accessed by using the menu on the left side of the page:

- Functions
- Networks
- Backups

- Settings
- Logs

5.2. Functions

The Functions page is responsible for installing and upgrading application software.



It is highly recommended to only install/upgrade software under guidance from Nuvation Energy. Incorrectly installing/upgrading software could render the Multi-Stack Controller inoperable.

Installed Functions			
Name	Version	Type	Status
cloud_logger	12.2.0	Standalone	Running
ndisplay	24.2.0	Standalone	Stopped
msc_application	5.2.0	Standalone	Stopped
msc_ui	2.2.0	Standalone	Stopped
msc_bundle	21.2.0	Bundle	Running
system_monitor	24.2.0	Standalone	Stopped
dashboard_framework	8.3.1-nuv24.2.0	Standalone	Stopped
remote_access	10.2.0	Standalone	Running

Figure 30. Nuvation Energy Platform Interface Function

The Functions card displays a list of all functions currently installed along with their respective versions.



It is normal for functions of type Standalone to display the Stopped status if one or more functions of type Bundle are present.

5.2.1. Installing a Function

1. Use the Choose File button to select a file with the extension .fn, .fns, or .fnz.
2. Click Install to install the function.

5.2.2. Upgrading a Function

1. Software may be upgraded in place by installing a newer version without uninstalling the older version.

5.3. Networks

The networks page shows the current network status of the Multi-Stack Controller and allows for configuration of the network interfaces.



Figure 31. Nuvation Energy Platform Interface Networks

5.3.1. Networking

There are two configuration cards on this page:

- External Network: Controls the External Ethernet network on the Multi-Stack Controller
- Bridge: Controls the Internal Ethernet network on the Multi-Stack Controller

Each card shows the following information:

- IP Address: The current IP of the Multi-Stack Controller on that network. Displays Unknown if no address is assigned
- Netmask: The current netmask of the connected network. Displays Unknown if no address is assigned
- DHCP: Whether DHCP will be used to acquire an address. Displays On for yes, and Off for no.
- Required: Whether the network interface is required to be up for proper operation. The Multi-Stack Controller will wait for up to 2 minutes during power-up for interfaces marked 'required' to come up before continuing with system startup
- STP: Spanning Tree Protocol. STP protects inadvertent loops within the network between grouped ports of the Multi-Stack Controller. When enabled, a delay of 30 seconds occurs between a network interface gaining carrier and beginning to forward traffic.
- MAC Address: The MAC address of the Multi-Stack Controller on the network. This address is not modifiable
- *Arrow in the header:* A green up-arrow indicates the network interface has a carrier. A red down-arrow indicates no carrier

If DHCP is disabled on the External Network, the following options will become available:

- DNS: The nameserver address to use for hostname lookups. If no DNS is available, set to 0.0.0.0 to disable
- Gateway: The gateway address to access the Internet from this network. If no gateway is available, set to 0.0.0.0 to disable



To communicate with the Multi-Stack Controller while the gateway is set to 0.0.0.0, the Multi-Stack Controller must be on the same subnet as the gateway.

Clicking the Edit Configuration button switches from showing the current status to showing the configured values. Values can be edited in the fields directly. The field will change from green to red if an invalid value is entered. Click Apply to apply and save the configuration.



The Platform Interface only supports configuring IPv4 networks. Operation of the Multi-Stack Controller on IPv6-only networks is not supported.



The DNS server will receive queries for Internet addresses (for example NTP server addresses), so the DNS server should forward queries to root nameservers for proper operation.



If 2 or more networks overlap with each other, the message "Error: Conflicting Networks" will appear. This may cause undesirable operation.



When applying External network settings involving DHCP, the old IP address will not be released, and this may be reflected by the status IP address not matching the configured value. This ensures that the device will always be reachable. A reboot of the device will release the old address.

5.3.2. Configuration

For the External network settings, the IP address and other corresponding information are automatically assigned by the DHCP server. For the Internal network settings, it is recommended to keep the default parameters which are listed as follows:

- IP Address: 192.168.1.10
- Netmask: 255.255.255.0

5.4. Backups

The Backups page is responsible for creating and restoring a state for the Multi-Stack Controller. That state includes configured settings, installed functions, and all logged data at the time of the backup creation.

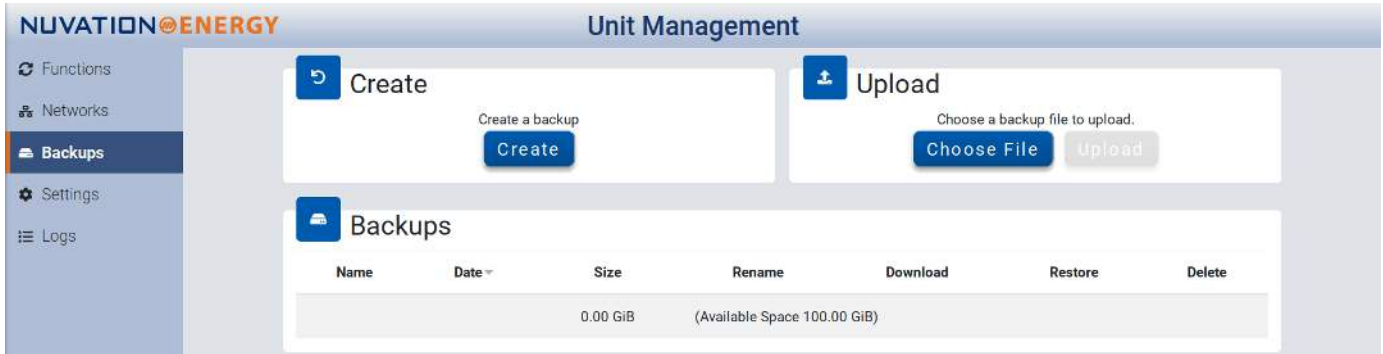

Figure 32. Nuvation Energy Platform Interface Backups

5.4.1. Create a System Backup

To create a backup of the current state of the system, click on Create. After a few minutes, a new backup file will be displayed under Backups with a name, creation date and size. To rename the file, click on Rename and input the name when prompted.

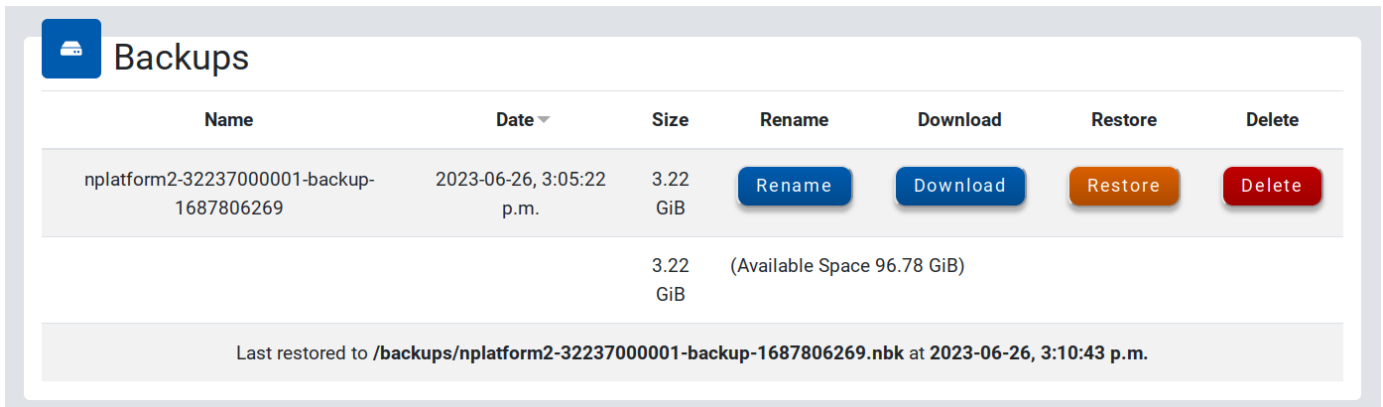

Figure 33. Nuvation Energy Platform Interface Backup file

A copy of the backup file can be downloaded on a [compatible computer](#) by clicking the Download button. At any time, a backup file can be deleted by clicking the Delete button.

5.4.2. Upload a Backup File

To upload an existing backup file, click on Choose file and select a .nbk file, then click the Upload button.



These files are relatively large and might take time to upload and download to the system.

5.4.3. Backup Restore

To restore the Multi-Stack Controller to a previous state, click the Restore button that corresponds to the .nbk file with the desired state.



Restoring will delete all current data on the device. Other backups will not be deleted.



If restoring a backup that contains different network settings, you may have to navigate your browser to the new address if this does not happen automatically.

5.5. Settings

The settings page is responsible for the following:

- Upgrading the Multi-Stack Controller
- Factory Resetting the Multi-Stack Controller
- Rebooting and Powering off the Multi-Stack Controller
- Setting Date, Time, and Timezone
- Importing and Exporting System Configuration Files

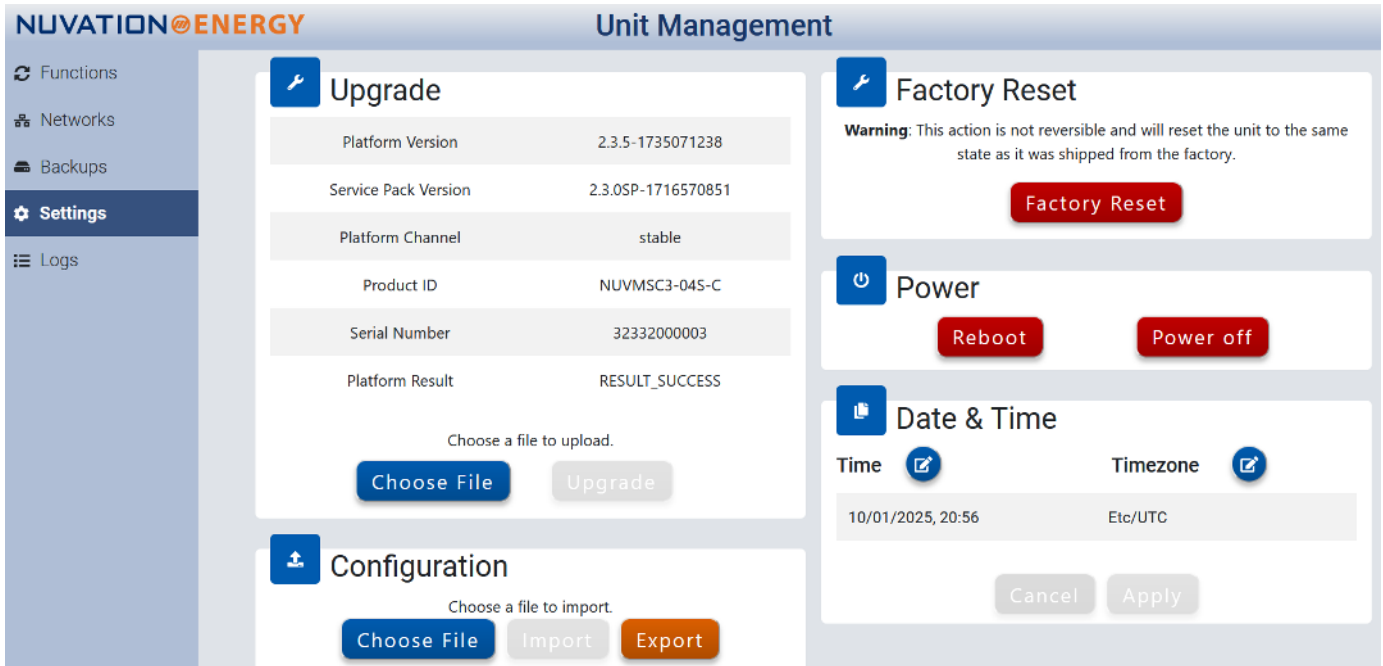

Figure 34. Nuvation Energy Platform Interface Settings



The above screenshot of the settings page is an example, the actual page will be different.

5.5.1. Upgrading the Multi-Stack Controller



It is strongly recommended to only upgrade software under guidance from Nuvation Energy. Incorrectly upgrading software could render the Multi-Stack Controller inoperable.

To upgrade the Multi-Stack Controller, click the Choose File button to select a file with an extension of .nup or .nosp. Then, click Upgrade to upgrade the unit.



It is always recommended to create a backup before upgrading.



The upgrade process may take a couple minutes, so please wait for the upgrade process to complete. The page will automatically refresh once the upgrade is complete.



Downgrading the Multi-Stack Controller is not an accessible feature. To revert to a previous version, please use the backup/restore feature. Please contact support@nuvationenergy.com for assistance with downgrading.

5.5.2. Factory Reset the System



It is strongly recommended to only factory reset the unit under guidance from Nuvation Energy. This action is not reversible and will reset the unit to the same state as it was shipped from the factory.

To reset the Multi-Stack Controller, click the Factory Reset button.



The reset process may take a few minutes, so please wait for it to complete. The page will automatically refresh once the reset is complete. However, the process will reset all network settings, so the Multi-Stack Controller may no longer be reachable without adjusting the computer's network settings.

5.5.3. Rebooting the System

To reboot the Multi-Stack Controller, click on the Reboot button and wait until the unit has been rebooted.



The Platform Interface will not be functional while the Multi-Stack Controller is rebooting.

5.5.4. Powering off the System

To power off the Multi-Stack Controller, click on the Power off button. Alternatively, pressing the physical power button on the unit will have the same effect. Following a shutdown, the physical power button can be pressed to restart the unit.



Before removing power from the Multi-Stack Controller, ensure that the unit has been powered off either through the Platform Interface or the physical power button. Abruptly removing power while the unit is still on may lead to internal file corruption or damage causing the unit to become inoperable.

5.5.5. Setting the Date, Time, and Timezone

The Timezone and Date/Time are individually configurable.

Setting the Date and Time

1. Click the blue edit-button to the right of the Time label.
2. Select the date and time by clicking on the field that is shown.
3. Click Apply to save the changes or Cancel to discard the changes.

Setting the Timezone

1. Click on the blue edit-button to the right of the Timezone label
2. Select the desired timezone from the dropdown list.
3. Click Apply to save the changes or Cancel to discard the changes.

5.5.6. Configuration Import and Export

Configuration files are YAML files that contain settings to be uploaded to the system.



Please contact support@nuvationenergy.com for more information on configuration files.

To upload a configuration file:

1. Click the Choose File button.
2. Select a YAML configuration file.
3. Click the Import button. A notification box will appear indicating the configuration was uploaded.



To get the configuration file currently uploaded on the system. Click the Export button.

5.6. Logs

The logs page allows debugging information to be downloaded from the Multi-Stack Controller. These logs can allow Nuvation Energy to more easily assist with support.

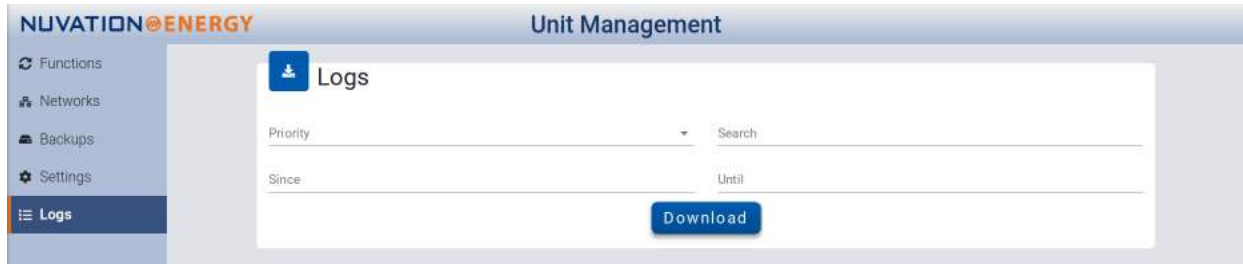

Figure 35. Nuvation Energy Platform Interface Logs

5.6.1. Downloading Logs

Set the Priority, Search, Since, and Until options as requested by Nuvation Energy support and click Download. Save the resulting .logx file to your computer so it can be relayed to Nuvation Energy support.

6. Communication Protocols

6.1. Modbus Protocol Support

Multi-Stack Controller implements the SunSpec Energy Storage Models (Draft 4) as the top-level Modbus interface to the product. Specifically the Multi-Stack Controller implements the 800 series Models.

6.1.1. Modbus TCP

This protocol is used for communications over TCP/IP networks. All register data is transmitted as big-endian (most significant byte first).

6.1.2. Implemented SunSpec Energy Storage Models

The SunSpec Energy Storage Models contain a number of 'Models' that can be implemented by vendors to describe a storage device at various levels of detail.

The SunSpec Information Model Reference (*SunSpec-Energy-Storage-Information-Models_Draft_4.xlsx*) is available for download under the Multi-Stack Controller section on the Nuvation Energy technical resources page located at <https://nuvationenergy.com/technical-resources>.

Details on supported 800 series Modbus Points can be found in the *Nuvation-Energy-Multi-Stack-Controller-Sunspec-Modbus-Examples-r1.1.xlsx* Excel document.

6.1.2.1. Common Model

This model primarily contains information to identify the device (e.g. manufacturer, model, serial number) as well as the version of software running on the device.

The Modbus address of this model is 0. [Table 7, "Common Model Points"](#) describes the points of the Common Model as implemented in the Multi-Stack Controller.

Table 7. Common Model Points

Point Name	Address	Description	Note
SunSpec_ID	0	'SunS' Identifier	Set to 0x53756e53
ID	2	Identifies Common Model Block	Set to 0x0001
L	3	Length of block	Set to 66
Mn	4	Device Manufacturer	Set to "Nuvation"
Md	20	Device Model Number	Set to "nController"
Opt	36	Options	Set to Multi-Stack Controller ID
Vr	44	Version Information	Set to Platform version
SN	52	Device Serial Number	Multi-Stack Controller SN
DA	68	Device Address	Set to 0x1

6.1.2.2. 802 (Battery Base Model)

This model describes a battery storage device. At this level, the critical operational information includes the charge and discharge current limits. All mandatory points are implemented.

6.1.2.3. 803 (Lithium-Ion Battery Model)

This model describes a lithium-ion battery in detail. Voltage, temperature, and current statistics are available at the pack and stack level within this model. All mandatory and most optional points are implemented.

6.1.2.4. 804 (Lithium-Ion String Model)

This model describes a lithium-ion battery stack and cell interfaces. This provides a communication interface with the individual stacks along with statistics about their cell interfaces. All mandatory points are implemented.

6.1.2.5. 805 (Lithium-Ion Module Model)

This model describes individual cells within a lithium-ion battery stack cell interface. It summarizes the cells balancing states, voltages, and cell temperature statistics in the cell interface. All mandatory points are implemented.

6.1.2.6. End Model

This model marks the end of the implemented Modbus address space.

6.1.3. SunSpec Energy Storage Models Structure and Nomenclature

This section is a clarification of terms used to describe SunSpec Energy Storage Models.

6.1.3.1. Points

All SunSpec Energy Storage Models are a collection of points (i.e. Modbus registers). These points can be one or more Modbus registers in length. By definition, each Modbus register is 16 bits wide. For points that are larger than one Modbus register, partial read accesses are not allowed. A Modbus request to a SunSpec point must read all registers that make up the point. Otherwise, a Modbus read/write error is returned on such an access.

For example, the SunSpec 802 model has the Evt1 point which is of type bitfield32. In this case, the point spans 2 Modbus registers and so a request to read this point must read 2 Modbus registers.

6.1.3.2. Repeating SunSpec models

The number of the SunSpec models 804 and 805 will vary depending on the stack and cell interface counts in the system. To ensure an accurate SunSpec model, the Multi-Stack Controller must be configured with the following parameters:

- Maximum number of installed stacks
- Maximum number of Cell Interface modules per stack
- Maximum number of cells per Cell Interface

For example, a four-stack system with four Cell Interface modules per stack will have four 804 models and sixteen 805 models.



These parameters are pre-configured for the maximum size of the system. Please contact support@nuvationenergy.com in case any of the above parameters are changed.

6.1.3.3. Fixed/Repeating Blocks

SunSpec Energy Storage Models are described as collections of Fixed and Repeating blocks of points. A Fixed block is a set of points that is always defined and never changes in its size. A Repeating block describes a set of related points (i.e. usually for a string of batteries) of which there could be multiple instances of the Repeating blocks. The points within a repeating block are the same but these sets of blocks are concatenated sequentially.

For example in the 803 model, there is a set of repeating blocks that describe data for a particular stack/string of batteries. Accessing the 803 repeating block corresponds to using a stack/string index (0, 1, 2, ...) to access the desired repeating block.

For a multi-stack system, the number of repeating blocks will be determined by the maximum number of stacks/strings, Cell Interface modules, and installed cells configured on the system:

- Stack repeating blocks are in models 803 and 804.
- Cell Interface repeating blocks are in models 804 and 805.
- Cell repeating blocks are in model 805.

Repeating blocks are taken into account in the length indicated in the model header.

6.1.3.4. Bitfields and Enumerations

Several points implemented by the Multi-Stack Controller are bitfields and enumerations. These points often specify status information or are used for control. For example, the bitfields EvtVnd1 and EvtVnd2 from the 802 model contain fault and warning statuses for the Multi-Stack Controller respectively. Other 802 points such as SetOp is read-write and is used to connect or disconnect the battery stacks. Details on 800 series bitfields and enums implemented by the Multi-Stack Controller can be found in the *Nuvation-Energy-Multi-Stack-Controller-Sunspec-Modbus-Examples-r1.1.xlsx* Excel document.

6.1.3.5. Unimplemented Points

Any SunSpec point that is not implemented by a vendor will generate an unimplemented response. The response will be a valid Modbus read response but all point data returned will report unimplemented values. The unimplemented values vary by type as listed in the following table.

Table 8. Unimplemented Point Values

Type	Width (bits)	Unimplemented Value (hexadecimal)
signed int	16	0x8000
unsigned int	16	0xFFFF
signed int	32	0x80000000
unsigned int	32	0xFFFFFFFF
enumeration	16	0xFFFF
enumeration	32	0xFFFFFFFF

A write to a writeable SunSpec point that is unimplemented will generate a Modbus write error.

6.1.3.6. Scale Factors

All SunSpec points are integer values (signed or unsigned). To account for different range values beyond the data size (i.e. greater than 65535 for an unsigned 16 bit value) or some fractional value (i.e. 1.1), some SunSpec points have scale factors associated with them. The scale factor is another point within the model which contains a signed integer exponent of base 10 that scales a corresponding point value. For example, a scale factor of 2 would result in multiplying the corresponding point by 100. Likewise a scale factor of -3 would result in a scale factor of 0.001.

6.1.4. Operational Cases for SunSpec Modbus Interface

There are two main operational cases for the control of Multi-Stack Controller over its SunSpec interface:

1. An external controller (sometimes called "Energy Storage Controller") is used to coordinate power control functions of the Multi-Stack Controller in conjunction with some other equipment (such as an inverter). This controller requires periodic and rapid responses of SunSpec point reads as well as some control over the operation of the Multi-Stack Controller (such as stack connectivity). If there is a loss of communication between this controller and the Multi-Stack Controller, the Multi-Stack Controller will disconnect the stack(s) as a safety precaution.
2. An owner/operator of a battery system requires control of the Multi-Stack Controller to monitor the activity of the batteries and track battery usage and its charge/discharge activities. This information can then be used to characterize the usage of the Multi-Stack Controller and to validate battery warranties of a vendor.

These two operational cases will be discussed in detail in the following sections.

6.1.4.1. External Controller Communicating Over SunSpec Modbus Interface

An external controller typically polls SunSpec points at a rate of 2–4 Hz. This controller reads data points required to manage current flow in the system. The following table summarizes the most important points an external controller may want to read.

Table 9. SunSpec Points Read by an External Controller

Model	Block	Point Name	Address	Scale Factor	Purpose
802	Fixed	CtrlHb	89	No	Heartbeat counter incremented every second
802	Fixed	Evt1	96	No	Bit field of all faults/warnings
802	Fixed	V	104	Yes	External DC voltage of the battery system
802	Fixed	A	114	Yes	Total DC current of the battery system
802	Fixed	AChaMax	115	Yes	Instantaneous maximum DC charge current
802	Fixed	ADisChaMax	116	Yes	Instantaneous maximum DC discharge current

A controller may also want to command Multi-Stack Controller to perform certain actions, such as connecting/disconnecting the battery. The following table provides the different writeable points in the SunSpec interface for different control functions:

Table 10. SunSpec Points Written to by an External Controller

Model	Block	Point Name	Address	Purpose
801	Fixed	AlmRst	90	Clears all latched alarms in the Multi-Stack Controller
802	Fixed	SetOp	120	Commands Multi-Stack Controller to connect/disconnect the battery

6.1.4.2. External Nuvation Energy BMS Monitoring Over SunSpec Interface

An external data logger may want to access a variety of data from the Multi-Stack Controller. In general, a data logger will not actively manage Multi-Stack Controller; normally, it will not initiate actions such as connecting a battery stack to the DC voltage bus or clearing faults. A data logger should connect to one of the read-only Modbus connections (if available) to allow the writable Modbus connection to be available for separate external control functions. The following table contains the SunSpec Energy Storage Models Points exposed by the Multi-Stack Controller that could be collected for logging purposes.

Table 11. Length Details

Model	Start Address	Length	Number of Models
start	0	2	1
Common	2	68	1
802	70	64	1
803	134	28 + 32 x S	1
804	162 + 32 x S	48 + 16 x CI	S
805	162 + 80 x S + 16 x S x CI	44 + 4 x C	S x CI
End	162 + 80 x S + 16 x S x CI + S x CI x (44 + 4 x C)	3	1



S = Number of Stacks on the system, CI = Number of Cell Interface modules per stack, C = Number of cells per Cell Interface.

Table 12. SunSpec Points Read by External Data Logger

Mod el	Block	Point Name	Address	Scale Factor	Purpose
802	Fixed	SoC	81	Yes	BMS State of Charge
802	Fixed	CtrlHb	89	No	BMS Heartbeat counter incremented every second
802	Fixed	Evt1	96	No	Bit field of all faults/warnings of a Multi-Stack Controller
802	Fixed	V	104	Yes	External DC voltage of the battery system
802	Fixed	SetOp	120	No	BMS requested connection state of all stacks/strings
802	Fixed	CellVMax	107	Yes	Maximum cell voltage measured
802	Fixed	CellVMaxStr	108	No	Module/String location of maximum cell voltage
802	Fixed	CellVMin	110	Yes	Minimum cell voltage measured
802	Fixed	CellVMinStr	111	No	Module/String location of minimum cell voltage
803	Fixed	ModTmpMax	138	Yes	Maximum module temperature
803	Fixed	ModTmpMaxStr	139	No	Module/String location for maximum module temperature
803	Fixed	ModTmpMin	141	Yes	Minimum module temperature
803	Fixed	ModTmpMinStr	142	No	Module/String location for minimum module temperature
802	Fixed	A	114	Yes	Total DC current of the battery system
803	Fixed	StrAMax	150	Yes	Largest DC current reported by a stack/string
803	Fixed	StrAMin	152	Yes	Smallest DC current reported by a stack/string
803	Repeat	StrSoC	166 +Index	No	State of charge for a stack/string
803	Repeat	StrSoH	167 +Index	Yes	State of health for a stack/string
803	Repeat	string.StrA	200 +Index	Yes	Current of a stack/string
803	Repeat	string.StrCellVMax	169 +Index	Yes	Maximum cell voltage of a stack/string
803	Repeat	string.StrCellVMin	171 +Index	Yes	Minimum cell voltage of a stack/string
803	Repeat	string.StrCellVMaxMod	170 +Index	No	Location of min/max cell voltages of a stack/string
803	Repeat	string.StrModTmpMax	174 +Index	Yes	Maximum module temperature of a stack/string

Model	Block	Point Name	Address	Scale Factor	Purpose
803	Repeat	string.StrModTmpMin	176 +Index	Yes	Minimum module temperature of a stack/string
803	Repeat	string.StrModTmpMaxMod	175 +Index	No	Location of min/max module temperatures of a stack/string
803	Repeat	string.StrEvt1	182 +Index	No	Alarms warnings and status bitfield of a stack/string
804	Repeat	lithium_ion_string_module.ModCellVAvg	804_start_address +55 +Index	Yes	Average voltage for all cells in the module
805	Repeat	lithium-ion-module-cell.CellV	805_start_address +44 +Index	Yes	Cell terminal voltage
805	Repeat	lithium-ion-module-cell.CellTmp	805_start_address +45 +Index	Yes	Cell temperature



In the Repeating block addresses used in the above table, the term Index for the 803 model is Index = Stack Index * Length of Repeating block. For the 804 model, Index = Cell Interface Index * Length of Repeating block. For the 805 model, Index = Cell Index * Length of Repeating block. See [Table 11, "Length Details"](#) for the value of 804_start_address and 805_start_address.

By definition, the 803, 804 and 805 Repeating blocks are 16 Modbus registers in length.

6.1.5. Accessing SunSpec Energy Storage Models

SunSpec Energy Storage Models are located contiguously in the Modbus address space starting at a base address of 0. The Common Model is always located first in this space. The End Model is always last and is used to denote the end of SunSpec Modbus registers. Each model located between the Common Model and the End Model has a numeric identifier as well as a length. A handy tool that can be used to explore the SunSpec Modbus registers for Multi-Stack Controller is modpoll.exe. It is available for free download at <http://www.modbusdriver.com/modpoll.html>.

Using modpoll.exe, the Common Model can be polled from a using the following command (assuming the device has an IP address of 192.168.1.21)

Polling example with Multi-Stack Controller IP address of 192.168.1.21

```
modpoll -m tcp -0 -r 0 -c 70 192.168.1.21

modpoll 3.10 - FieldTalk(tm) Modbus(R) Master Simulator
Copyright (c) 2002-2021 proconX Pty Ltd
Visit https://www.modbusdriver.com for Modbus libraries and tools.

Protocol configuration: MODBUS/TCP, FC3
Slave configuration...: address = 1, start reference = 0 (PDU), count = 70
Communication.....: 192.168.1.21, port 502, t/o 1.00 s, poll rate 1000 ms
Data type.....: 16-bit register, output (holding) register table
```

```
-- Polling slave... (Ctrl-C to stop)
[0]: 21365
[1]: 28243
[2]: 1
[3]: 66
.
.
.
[68]: 1
[69]: -32768
```

7. External Interfaces

7.1. Ethernet

Four 10/100/1000 Mbps and two 1/10 Gbps, Cat6-rated Ethernet jacks are provided. Any Cat5e-rated or higher Ethernet cable of suitable length may be used to connect to these jacks.

Refer to the network port connection map [Table 1, "Network Port Connection Map"](#) and [Figure 7, "Multi-Stack Controller port types"](#).

7.2. SFP+ Interfaces

Two SFP+ ports are provided. These ports can be equipped with any suitable transceiver depending on the application.

Refer to the network port connection map [Table 1, "Network Port Connection Map"](#) and [Figure 7, "Multi-Stack Controller port types"](#).

7.3. Power Button

This button is a momentary tactile switch that powers the Multi-Stack Controller **ON** and **OFF**. Holding this button for several seconds causes a *forced shutdown*.

7.4. DC Power Connector

The DC Power connector accepts a standard locking male barrel plug (2.5 mm I.D × 5.5 mm O.D, positive center, 5/16" - 32 threaded nut).

The DC Power connector provides a nominal 12 V DC to the Multi-Stack Controller, but will tolerate an input voltage between 11.4 and 12.6 V DC.



The external supply has its negative input connected to earth ground through the Multi-Stack Controller's chassis.

8. Troubleshooting

8.1. Faults

When a pack level fault occurs, all stacks are disconnected. The following sections describe the different faults and the conditions that trigger them. In general, all warnings have a similar trigger condition as their corresponding fault. The following discussion will focus on the term fault and all descriptions can be applied to the compatible warning. For faults observed at the stack level please refer to the *Troubleshooting* section in the BMS level *Product Manual*.



Please contact support@nuvationenergy.com for details of the configuration and operation of any of the below triggers.

8.1.1. Controller Heartbeat

`faults:control_watchdog`

- Fault indicating that an external controller did not provide a heartbeat update within the configured period.

8.1.2. Ready Stacks

This fault represents a configurable minimum limit of how many stacks must be ready and still have the pack remain connected and manage the battery power.

`faults:stacks_ready`

- Fault indicating that the minimum number of ready stacks for the pack has not been satisfied

Refer the Stack Status page ([Section 4.3, "The Stack Status Tab"](#)) on the Operator Interface to observe which stacks have been either disabled, are in Service Lockout, or have faulted.

8.1.3. Configuration Fault

`faults:config_fault`

- Fault indicating that no configuration file is loaded or a configuration file failed to load.
- Fault indicating that a configuration file is loaded but a stack IP address is missing or an incorrect Modbus or HTTP ports were set up.

The configuration fault does not have a corresponding warning and is not configurable.

8.1.4. BMS Firmware Mismatch

`warnings:stacks_bms_version`

- Warning indicating that the Multi-Stack Controller has read a stack-level BMS firmware version different than the expected. Perform a firmware upgrade on the affected stacks.

8.1.5. Current Imbalance

faults:current_imbalance

- Fault indicating that the current difference between the stack with the highest current and the stack with the lowest current is greater than the configured threshold.

8.2. Lost/Forgotten IP Address

The Multi-Stack Controller is resolvable using mDNS via a compatible computer. Refer to [Section 4.1.1, "External Computer Requirements"](#) for details.



Depending on the network interface used on the PC, this process may not work due to differing security and IP configurations. If the only IP discovered is the IP of the PC, the network interface is not suitable and another one will need to be used. This issue is most common with USB to Ethernet dongles.

8.2.1. Wireshark (Windows/Linux)

1. Download/install Wireshark on a PC (<https://www.wireshark.org/>)
2. Connect the PC directly to the Ethernet port on the Multi-Stack Controller
3. Start a Wireshark capture on the network interface connected to the Multi-Stack Controller
4. In the 'filter' field, enter in `arp.isgratuitous` and press enter
5. Either reboot the Multi-Stack Controller, or unplug/plug the Ethernet cable
6. The device should send a 'Gratuitous ARP' on the Ethernet network. In Wireshark the 'Info' field looks like: `Gratuitous ARP for <IP> (Request)` where the `<IP>` is the address for the Multi-Stack Controller
7. Once that is complete, update the PC network settings to match the Multi-Stack Controller and connect the Operator Interface.

8.2.2. Netdiscover (Linux only)

1. Install netdiscover on a PC (on Debian based systems use: `sudo apt install netdiscover`)
2. Connect the PC directly to the Ethernet port on the Multi-Stack Controller
3. Run `sudo netdiscover -i <interface> -p` where `<interface>` is the network interface connected to the Multi-Stack Controller
4. Either reboot the Multi-Stack Controller, or unplug/plug the Ethernet cable
5. The device address and MAC will show up in netdiscover once an ARP packet is sent
6. Once that is complete, update the PC network settings to match the Multi-Stack Controller and connect the Operator Interface.



In the event the IP address cannot be discovered, a factory reset operation must be carried out to restore the BMS to its default IP configuration.

Appendix A: Operating Limits



Exceeding the maximum ratings will damage the module.

Electrical Characteristics

Symbol	Parameter	Conditions	Min	Typ	Max	Units
Power Specifications						
+Vin	Input Voltage	-	11.4	12	12.6	V DC
	Input Current	+Vin = 12 V DC	-	7.5	12.5	A DC
Ethernet Specifications						
ETH RJ45: 1-4	Ethernet Connection Speed	10BASE-T 100BASE-TX 1000BASE-T	10	-	1000	Mb/s
ETH RJ45: 5,7	Ethernet Connection Speed	1GBASE-T 10GBASE-T	1	-	10	Gb/s
ETH Twisted_Pair: 1-4	Ethernet Cable Rating	-	Cat 5e	-	Cat 6	
ETH Twisted_Pair: 5,7	Ethernet Cable Rating	-	Cat 6	-	-	
ETH SFP+: 6,8	SFP+ Port Speed	-	1	-	10	Gb/s
ETH_Connector	Ethernet jack rating	-	-	Cat6	-	

Environmental Conditions

Symbol	Parameter	Conditions	Min	Typ	Max	Units
Thermal Specifications						
T _a	Operating Temperature	-	5	25	40	°C
	Storage Temperature	-	-40	25	70	°C
Humidity Specifications						
RH	Operational RH	Non-Condensing	8	-	90	%
	Storage RH	Non-Condensing	5	-	95	%
Shock and Vibration Specifications						
Vertical	Vertical Shock/Vibration	-	-	-	10	m/s ²
Longitudinal	Longitudinal Shock/Vibration	-	-	-	10	m/s ²
Transverse	Transverse Shock/Vibration	-	-	-	10	m/s ²
Pulse Vibration	On each axis	-	-	-	245	m/s ²

If the Multi-Stack Controller is stored at temperatures below 5 °C, it must be warmed up in a 20 °C or warmer environment for 45 minutes before applying power. Powering the unit below 5 °C may impact data logging or cause other unexpected behaviour.

Standards and Certifications

The Multi-Stack Controller has been designed to meet the requirements of SAE J2464 (shock) and SAE J2380 (random vibration).

The following directives and standards apply to the Multi-Stack Controller:

- EMC/EMI: 2014/30/EU (EMC Directive)
- Electromagnetic Compatibility Regulations 2016
- FCC Part 15 Subpart B
- ICES-003
- VCCI 32-1
- AS/NZS CISPR 32
- BS/EN55032
- BS/EN55035
- BS/EN 61000-3-2
- BS/EN 61000-3-3
- BS/EN 61000-4-2
- BS/EN 61000-4-3
- BS/EN 61000-4-4
- BS/EN 61000-4-5
- BS/EN 61000-4-6
- BS/EN 61000-4-8
- BS/EN 61000-4-11
- Green Environment: 2011/65/EU (RoHS Directive)
- EC 1907/2006 (REACH)
- 2012/19/EU (WEEE Directive)
- Product Safety: 2014/35/EU (LVD Directive)
- Electrical Equipment (Safety) Regulations 2016
- UL/CSA 62368-1 (USA and Canada)
- IEC 62368-1

Appendix B: Ordering Information

This section provides orderable part numbers for Nuvation Energy’s offerings of Multi-Stack Controller modules and related accessories.

Product Part Number	Product Name
NUVMSC3-04S-C	Multi-Stack Controller, Compact, up to 4 stacks
NUVMSC3-08S-C	Multi-Stack Controller, Compact, up to 8 stacks
NUVMSC3-12S-C	Multi-Stack Controller, Compact, up to 12 stacks
NUVMSC3-16S-C	Multi-Stack Controller, Compact, up to 16 stacks

Depending on the region the product is shipped to, either a NEMA 5-15P or CEE 7/7 12V lockable power adapter is included in the box.

<<

Appendix C: Battery Topology Terminology

Energy storage systems are hierarchical in nature. Nuvation Energy has adopted the following definitions for battery pack topology:

Cell

A Cell is the smallest unit of energy storage distinguishable by the Battery Management System. One Cell, as defined from the perspective of the BMS, may actually consist of one or more electrochemical cells connected in parallel. This subtlety is reflected in the nomenclature for completeness. For example, a "1p" Cell refers to a single electrochemical cell, while a "2p" Cell refers to two electrochemical cells connected together in parallel. From the perspective of the BMS, these topologies appear identical except for the capacity of the Cells.

Group

A Group is a set of Cells connected in series and managed together. For example, 12 "1p" Cells in series are referred to as a "12s1p" Group, while 16 "2p" Cells in series are referred to as a "16s2p" Group. Grouping of Cells is highly application-specific and is defined in how BMS hardware interfaces are physically wired up to Cells.

Stack

A Stack is one or more Groups connected in series. For example, five "14s2p" Groups connected in series could be described as a "5g14s2p" Stack. However, it is far more common to describe it as a "70s2p" Stack.

Bank

A Bank is one or more stacks connected in parallel. For example, three "70s2p" Stacks connected in parallel are referred to as a "3x70s2p" Bank.

Pack

A Pack is one or more Banks connected in series.

Appendix D: Best Practices

This section describes important concepts which need special attention to achieve a reliable installation.

Excess Cable Management

During the first prototype system build, it is possible to encounter cable lengths that are too long for your system. Leaving the excess cable length unmanaged can result in a messy system installation.

If reducing the cable length is not feasible or if there is no time to physically modify the lengths, a common solution is to wrap the excess cable length in a coil and fasten the wire loop in the cabinet. This basic tactic has the undesirable effect of creating an air-core transformer which will couple EMI into the cable extremely well.

The best solution to cable length management is to bundle the excess length in a figure-8 pattern. This prevents the bundle from turning into an air-core transformer since the direction of current in one side of the figure-8 turns opposite to the current in the other side. It is recommended to use the figure-8 method if physically reducing the cable length is not possible.

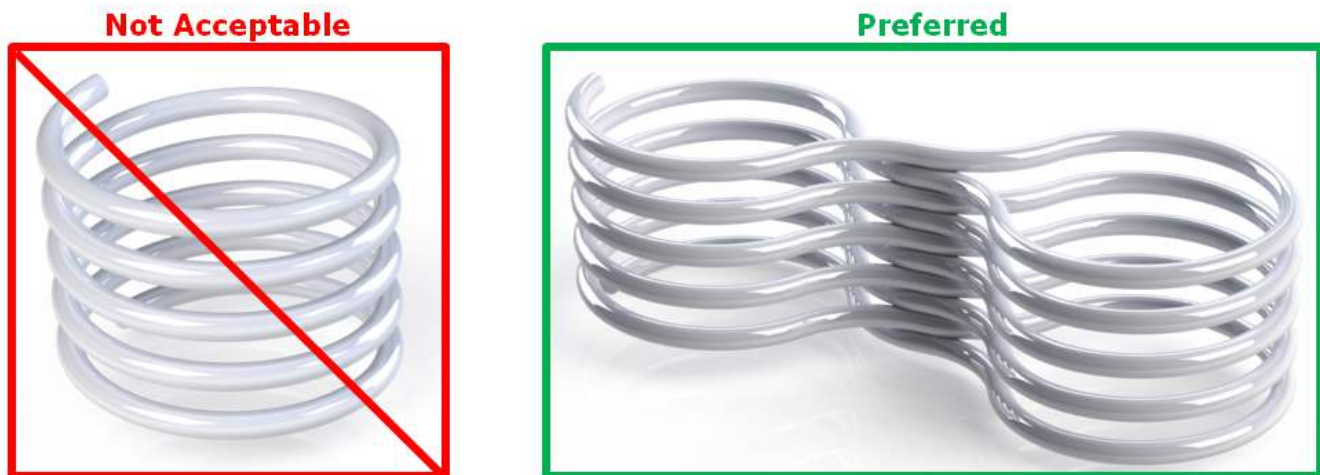

Figure 36. Excess Cable Management Examples

Security



This section is provided as guidance only and experts in security and the broader system must be consulted on any security decisions.



Security for the entire system and site must be considered, not just for individual Nuvation Energy products.

It is recommended evaluating each site and system to assess the risk level and impacts of the system not operating properly. Security restrictions protect against both accidental misuse and intentional

attacks. Each added layer of security will impact the ability to diagnose and resolve system problems and analyze system performance. The costs of system security should be proportional to the risk level of that system.

The sections below outline the best practices for maintaining a secure system.

Physical Security

Physical security measures are designed to deny unauthorized physical access to Nuvation Energy products and the larger systems. Physical security can include barriers, locks, access control, surveillance, guards, intrusion detection/alarms, and other physical security systems.

Ensuring all equipment is physically secure is the first and most important step in protecting the system. Below are some recommended best practices for the physical security of the products:

- Nuvation Energy products should be physically secured in a locked enclosure, room, or building to restrict access. This physically secured area will be referred to as the 'secure zone'.
- The 'secure zone' access should be restricted to authorized personnel only.
- Authorized personnel should be trained to operate the equipment and follow the security process.
- Any unauthorized personnel should be supervised at all times.

Outside the products themselves, access to equipment and connections should also be secured, such as:

- Cells/battery modules
- PCS/inverters
- SCADA systems
- UPS/emergency power equipment
- High and low power cables and measurement wires
- Communication cables (i.e. Ethernet, USB, Linkbus, etc.)
- Networking equipment (i.e. routers, switches, transceivers, etc.)
- Buttons/control panels (i.e. E-stop, touchscreens, etc.)
- Any other critical equipment/connections that might compromise the site

Network Security

The networking on Nuvation Energy products uses Ethernet-based TCP/IP communications. Throughout this section, references to the nController apply to both Nuvation Energy Multi-Stack Controller and Energy Management System products. A network security analysis for any third party equipment on the network should be conducted in consultation with the equipments' manufacturer. Below are some recommended best practices for network security of Nuvation Energy products:

- Nuvation Energy products should be on an isolated network where only trusted equipment can operate, and trusted personnel can access. This network will be referred to as the 'secure network'.

- The 'secure network' should be within the 'secure zone' (see the [Physical Security](#) for details)
- The 'secure network' should be established through either a:
 - Physically isolated network (i.e. no connection to any other network, otherwise known as 'air gapped')
 - Firewall isolated network (i.e. router, smart switch, or other equipment with packet filtering to the 'secure network')
- The nController should be used to isolate the stack BMSs from the site network through the nController 'Internal/Bridge' network. These two networks must be isolated on separate subnetworks with separated IP address ranges.

An example of a 'secure network' topology with a router based firewall, Multi-Stack Controller, and Nuvation Energy stack BMS units isolated on the 'Internal/Bridge' network is below:

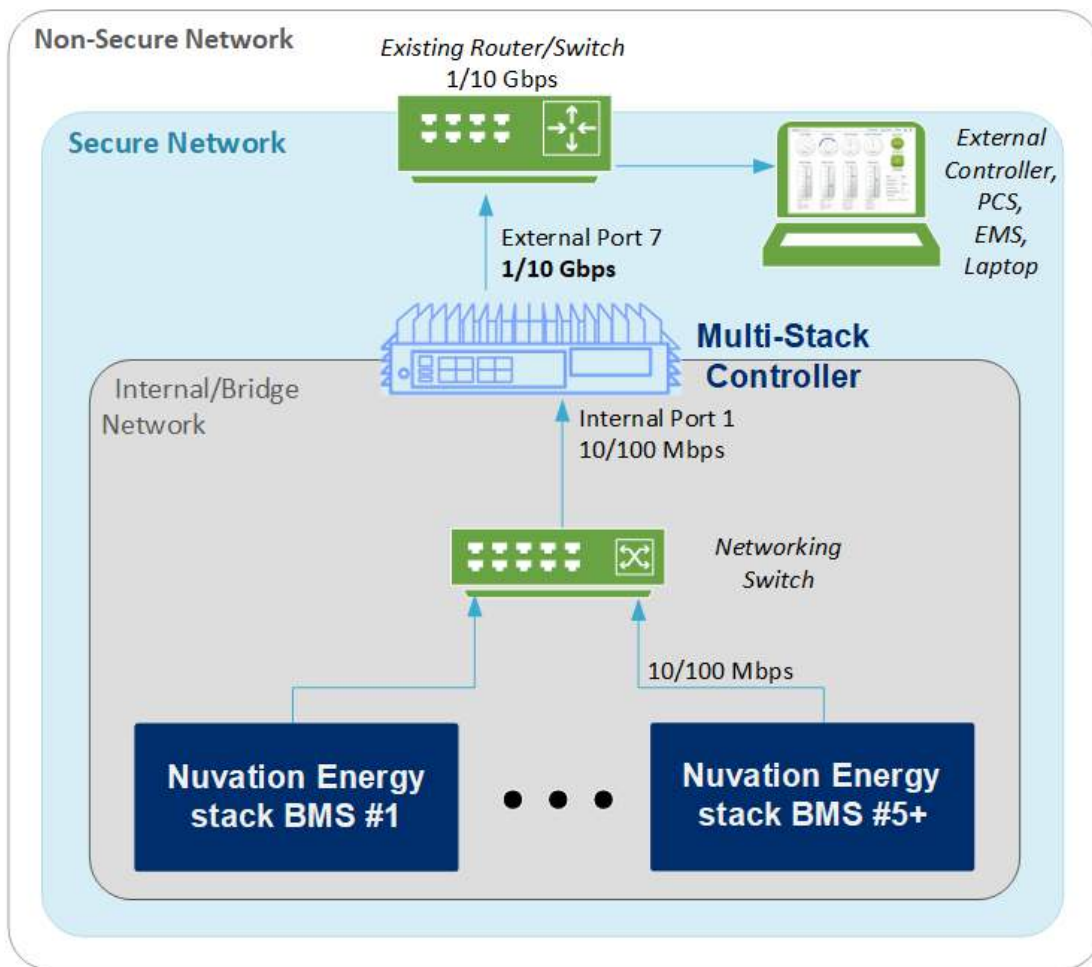

Figure 37. Networking configuration for a Multi-Stack Controller with secure and internal network

Inbound Protocols and Ports

All the open ports listening on the Multi-Stack Controller with the network protocols are listed below. Unless specified, the protocols are not encrypted or authenticated.

- TCP Port 80/3003/7770 (HTTP)
- TCP Port 502/503 (Modbus)
- UDP Port 5353 (mDNS)
- TCP Port 443 (HTTPS - encrypted)
- TCP Port 22 (SSH - encrypted/authenticated)

Outbound Protocols

All Nuvation Energy products implement the essential outbound services for proper operation with modern networking equipment, listed below. Unless specified, the protocols are not encrypted or authenticated.

- Broadcast on network segment (ARP, STP)
- UDP Port 67/68 (DHCP)

The nController has the following additional services listed below. Unless specified, the protocols are not encrypted or authenticated.

- UDP/TCP Port 53 (DNS)
- UDP Port 5353 (mDNS)
- UDP Port 123 (NTP)
- UDP Port 1194 (VPN - Nuvation Energy support only, encrypted/authenticated)
- TCP Port 443 (HTTPS/WSS - Nuvation Energy Cloud Services <https://nuvation.energy>, encrypted)

Blocking outbound protocols can be done in a similar way to inbound protocols (i.e. firewalls). For more information on the above services and to configure or disable services, contact support@nuvationenergy.com. Some services such as mDNS cannot be disabled.

Operator Interface Unlock Password

The Operator Interface for both single and multi-stack systems can be configured with a password which restricts some features in the products. The unlock password protects against accidental misuse of the products during normal operation.



The Operator Interface uses HTTP which does not encrypt connections and requires a secured network to protect against malicious intent.

Appendix E: Appendix D: List of Supported Equipment

Supported UPS Devices

The following UPS devices have been tested and are supported with Nuvation Energy products:

- APC SRT3000RMXLA
- APC BR1000MS
- CPS CP1500PFCLCD
- CPS CP1350PFCLCD



Nuvation Energy guarantees product compatability with the above family models.

Excluding the UPS devices mentioned above, following family models are likely to be compatible, however have not been thoroughly tested by Nuvation Energy:

- APC Smart-UPS family models
- Other APC Back-UPS family models
- CPS CP*PFCLCD family models
- CPS OR*PFCRT* family models
- CPS BRG*AVRLCD family models
- CPS CP*AVRLCD family models
- CPS CP*AVR* family models



Nuvation Energy **does not** guarantee product compatability with the above family models.



The Multi-Stack Controller can communicate with UPSes via USB and Ethernet.

Supported Display Devices

Nuvation Energy products are configured to support a display before shipment. If you wish to configure a display after shipment, please contact support@nuvationenergy.com. The following touchscreen devices have been tested and are supported with Nuvation Energy products:

- Acer UT241Y
- Dell P2418HT
- Zhixanda GC1016-C



Display hotplugging is not supported. Users must either connect the display before device startup or connect the display and reboot the device.

Specification for compatible displays supported by Nuvation Energy products:

- Display Connection: VGA
- Minimum Resolution: 1024 x 768
- Maximum Resolution: 1920 x 1200
- Touch Panel Connection: USB



Most touchscreens with **USB HID devices with multi-touch** are supported. Also most USB keyboards and mice are supported. Please contact support@nuvationenergy.com with a model and Nuvation Energy can attempt to determine if it will work prior to purchase.

From time to time Nuvation Energy will make updates to products in response to changes in available technologies, client requests, emerging energy storage standards, and other industry requirements. The product specifications in this document, therefore, are subject to change without notice.

© 2025 Nuvation Energy